

SMARTENERGY > DELIVERY

RELIABILITY
SAFETY

Outdoor lighting service guide

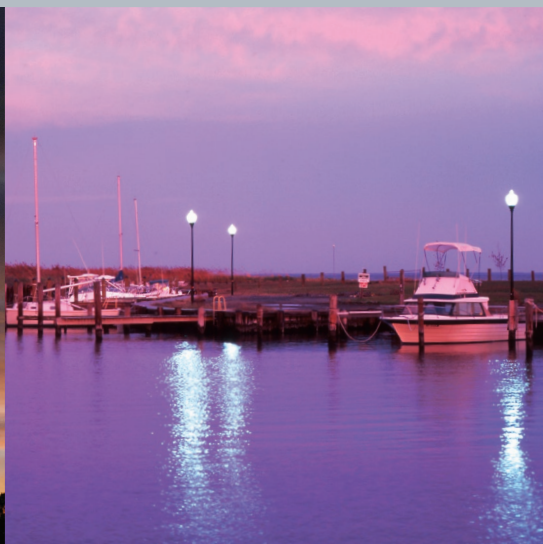

An Exelon Company

[BGE.COM](https://www.bge.com)

Before you dig, every dig.

MISS UTILITY

It's the law.

811 or 1.800.257.7777

One call to Miss Utility can save time, money and lives.

Before you pick up any equipment, pick up the phone and call Miss Utility.

Miss Utility will notify all applicable utility companies and see to it that your job site is marked for all underground utility lines. One simple phone call can save you the time and hassle of dealing with job site mistakes and delays. Not to mention decrease liability, prevent damage, reduce injuries and possibly save lives. After all, safety is everyone's job.

Call Miss Utility, at least 48 hours prior to work, at 811 or 1.800.257.7777.

Dig Safely CHECKLIST

1. Call Miss Utility at 811 or 1.800.257.7777 at least 48 hours prior to work.
2. Allow the required time for utilities to mark the underground lines.
3. Respect and protect all marks/flags.
4. Excavate with care. Take all reasonable actions to properly protect, support and backfill underground utility lines.
5. Immediately notify the utility if an underground utility line is damaged.
6. If damage creates an emergency, take immediate steps to safeguard life, health and property.

Please check with your individual jurisdictions with regard to waiting times and specific digging guidelines.

For more information, contact Miss Utility or check online at www.missutility.net.

INTRODUCTION

BGE provides this manual for customers who want to install Street Lighting (SL) or Private Area Lighting (PL) — with guidelines important to developers, general contractors, builders, architects, engineers, and private property and municipal customers.

Lighting service includes:

- SL – unmetered street lighting service supplied from overhead or underground facilities on dedicated public streets and roads where required by City, Town, County, or other Municipal or Public Agency, or by an incorporated association of local residents. A builder or developer may contract for street lighting service prior to the execution of a contract with the ultimate customer.
- PL – unmetered outdoor area lighting of private property including recreation and park areas, parking lots, storage areas, and non-dedicated roadway systems such as those in garden-type apartments, condominiums, mobile home parks, and government agency properties.

Whether planning new construction, relocating or changing existing lighting, these guidelines can help keep the lighting project on track.

BGE is committed to providing safe and dependable electric lighting service. Our goal is to install outdoor lighting service promptly and safely while meeting all construction codes and standards.

This publication is a guide to BGE's requirements but does not cover all rules and regulations. BGE Outdoor Lighting Account Representatives can answer questions and guide customers through the process. Please call BGE at **410.470.9446 (toll free 800.685.0123)**, or visit us online at **bge.com/outdoorlighting** for additional information and most up to date product offerings.

A PDF version of this manual can also be found at **bge.com/outdoorlighting**.

TABLE OF CONTENTS

1	LIGHTING SERVICES AVAILABLE	
	Street Lighting	2
	Private Area Lighting	2
	Installations	2
	Change-out Program	2
	Relocations	3
	Street Light Removals	3
	Private Area Light Removals	3
	Street Light Refurbishment	3
	Street Light Maintenance	3
	Other Maintenance Related Information	4
	Private Area Maintenance	5
	Temporary Street Lighting	5
	Energy Efficient Luminaire Products	5

2	GENERAL INFORMATION	
	The Four Stages of the Process	8
	Important Information and Responsibilities	15
	Retail Electric Service Tariff	18

3	LIGHTING SPECIFICATIONS AND ILLUSTRATIONS	
	Sample Customer Site Plan	21
	Street Tree Placement	22
	Street Light Pole Locations	23
	Traffic Protection (Bollard/Concrete Pole Base)	24
	Customer Installation of Conduits	25
	Pad Mounted Transformers	31

4	DEFINITIONS AND FREQUENTLY ASKED QUESTIONS	
	Definitions	41
	Frequently Asked Questions	44

LIGHTING SERVICES AVAILABLE

STREET LIGHTING (SL)

BGE Outdoor Lighting offers unmetered street lighting service supplied from overhead or underground facilities on dedicated public streets and roads where required by City, Town, County, or other Municipal or Public Agency, or by an incorporated association of local residents. A builder or developer may contract for street lighting service prior to the execution of a contract with the ultimate customer.

Customers may desire a durable, safe, and attractive streetscape to withstand the test of time, to celebrate a unique heritage and distinctive neighborhood, to reinforce a sense of place and economic vitality, and to promote visual continuity of quality streetscape components in an effort to enhance desirable destinations for visiting, working, playing and living. Revitalized streetscapes can assist in attracting new residents, businesses, and visitors to the richness of the urban landscape. With careful implementation, streetscape design guidelines can help to advance this revitalization process, while creating safer public spaces and a greater sense of community pride.

BGE installs streetscape lighting based on the customer's specifications. Contact a BGE Outdoor Lighting Account Representative to discuss design/engineering specifications and installation requirements.

PRIVATE AREA LIGHTING (PL)

BGE's Private Area Lighting program offers unmetered outdoor area lighting of private property including recreation and park areas, parking lots, storage areas, and non-dedicated roadway systems such as those in garden-type apartments, condominiums, mobile home parks, and government agency properties.

BGE can provide uplighting to businesses and buildings. The primary technique employed will consist of mounting architectural floodlights on existing streetlights to achieve a uniform wash of light to either flatten out facade features or to exaggerate the textural nature of a surface.

The Private Area Lighting monthly contract is a lease for lighting equipment. At the end of the contract term, billing continues on a month to month basis until the contract is terminated by at least 30 days notice from the customer or BGE.

INSTALLATIONS

BGE Outdoor Lighting is available to assist customers in determining the most effective outdoor lighting system to provide safety, enhanced visibility, security, and aesthetics. When determining the type of lighting required, the account representative will consider the lighting needs of the area to be illuminated (such as public streets, private parking areas, open spaces, fence lines, building, etc.) as well as provide guidance regarding design and layout.

Once a customer has entered into an agreement with BGE Outdoor Lighting, signed all necessary documents and taken care of any upfront charges, installation of poles, ornamental or non-ornamental light fixtures, cable, and other necessary equipment for the project can begin.

CHANGE-OUT PROGRAM

When newer technologies become available or a change in the illumination level of the customer's lighting is required, BGE Outdoor Lighting offers a Change-out Program to replace older luminaire and pole styles. This program allows for updated or different products to be installed at little or no upfront cost. (Changes prior to any contract's expiration date may incur upfront charges).

Mercury vapor fixtures may be removed and replaced with equipment comparable in wattage based on federal mandates (see Public Law 109-58, Energy Policy Act of 2005, Section 135) and monthly charges will be adjusted accordingly.

RELOCATIONS

Customers can request relocation of their outdoor lighting equipment. Costs will be incurred for moving customer or BGE owned or leased lighting. If a customer requests a fixture or pole be removed and, within a year, requests a new installation at or near the original location, the customer will be charged at cost for this relocation, per Schedules SL and PL of BGE's Retail Electric Service Tariff.

Please call BGE at 410.470.9446 (toll free 800.685.0123), or visit us online at bge.com/outdoorlighting for additional information and most up-to-date product offerings.

STREET LIGHT REMOVALS

Should the customer request BGE to permanently remove the customer-owned street lighting, the customer shall pay all costs incurred as a result of the removal of customer-owned street lighting. The customer may elect to remove customer-owned fixtures and poles themselves, but must first advise BGE of their intention and allow adequate time for the de-energizing of the circuit and poles to be removed. In this case, labor charges to de-energize each location will be charged to the customer.

Should the customer request a BGE owned fixture or pole be removed, labor charges to de-energize and remove each location will be charged to the customer.

PRIVATE AREA LIGHT REMOVALS

Should a customer request BGE Private Area Lighting equipment be removed, and the initial contract term has been satisfied and 30 day termination notice given, the customer will not be charged any removal costs. If a removal request is made prior to the initial contract term being satisfied, the customer will be charged for early termination per Schedule PL of BGE's Electric Retail Tariff.

STREET LIGHT REFURBISHMENT

BGE provides luminaire refurbishment services for a set fee, per Schedule SL of BGE's Electric Retail Tariff. At the municipal customer's request and when mechanically possible, BGE will refurbish dilapidated customer owned luminaries to as close to 'as new' condition as possible.

STREET LIGHT MAINTENANCE

Customers may choose from the following types of **street light maintenance** service:

1. BGE provides, owns and maintains all equipment (listed and priced under Monthly Rate 2 & Monthly Rate 3 of the Schedule SL).
2. BGE furnishes, installs and sells those items in Monthly Rate 2 of the Schedule SL, excluding cable, at the Customer's expense. Customers can choose to have BGE perform maintenance services provided for in Monthly Rate 3 of the Schedule SL. Maintenance, not included in Monthly Rate 3, but on equipment supplied exclusively by BGE circuitry (e.g., fixture changes, ballast replacement), is performed by BGE at the Customer's expense. If Customers choose to perform their own maintenance, a disconnect means acceptable to the Company and the local authority having jurisdiction must exist. Customers are responsible for all costs for disconnect means above and beyond what is provided by BGE design standards.
3. BGE installs Customer supplied/owned equipment not included in Monthly Rate 2(b), (c), and (e) of the Schedule SL. Maintenance of this equipment follows the same provisions as delineated in paragraph (c) 2 of the Schedule SL.

STREET LIGHT MAINTENANCE (CONT'D)

4. If Customers desire to install, own and maintain their own lighting equipment (e.g., traffic, sign, street), Customers must provide a point of disconnect. In this case, BGE will provide energy under Monthly Rate 1. Maintenance as described in Monthly Rate 3 of the Schedule SL is optional for street and sign lighting.
5. Monthly Rate 3 of the Schedule SL, Bundled Preventive and Reactive Maintenance, is the default maintenance service for Customers renting fixtures under Provision (c) 1 of the Schedule SL and for Customers owning their own fixtures under Provisions (c)2 and (c) 3 of the Schedule SL and choosing to have the Company perform maintenance service under Monthly Rate 3. The Preventive Maintenance service provided under Monthly Rate 3 includes scheduled replacement of lamps and cleaning of glassware, and lamp renewal (including photocontrol and fuse) as needed. The Reactive Maintenance service involves replacement of lamps (fuses or photocontrol) performed with reasonable promptness upon notification to the Company. Monthly Rate 3, Reactive Only Maintenance, is an optional service for these Customers provided upon Customer request. The Reactive Only Maintenance service involves replacement of lamps (fuses or photocontrol performed with reasonable promptness upon notification to the Company. For customers who choose the Reactive Only Maintenance service or who choose to have no maintenance performed pursuant to Provision (c) 4 of the Schedule SL, the Company will not perform Preventive Maintenance service on the Customer's behalf. For customers who choose the Bundled Reactive and Preventive Maintenance service after participating in the Reactive Only Maintenance service or after choosing to have no maintenance performed pursuant to Provision (c)4, the Customer's lights will be preventively maintained as part of the Company's normal 6 to 8 year Preventive Maintenance cycle. Customers choosing either the Bundled Reactive and Preventive Maintenance service or the Reactive Only Maintenance service will be covered by this elected program for all lights under their bill account(s).

OTHER MAINTENANCE RELATED INFORMATION

In the case of Customer owned equipment, BGE does not inspect or maintain lamp poles, lamp pole bases or other related equipment, and nothing contained in this Schedule SL shall be construed to extend BGE's obligation to inspect or maintain any part of such Customer-owned lamp poles, lamp pole bases or related equipment. Additionally, replacement or repair of Customer-owned equipment, other than that which is provided under Monthly Rate 3, is the responsibility of the Customer and subject to Provision c(2) of the Schedule SL. Glassware replaced on Customer-owned equipment installed under Provision c(2) or c(3) of the Schedule SL will be performed by BGE on an as needed basis (typically every 6-8 years) and charged to the Customer.

When a Customer-owned lamp pole, fixture, and/or associated equipment is damaged as a result of an accident, weather, vandalism, etc., BGE may repair/replace as necessary, under agreement with the Customer, and attempt to bill the party at fault (where applicable). But, if BGE cannot collect the damages from the responsible party, the Customer shall pay for the repair/replacement. However, Customer's agreement is not necessary for BGE to respond to damaged Customer-owned lamp pole, fixture, and/or associated equipment in order to make the equipment and area safe. Customer will be responsible for BGE's costs to respond and make safe if the costs cannot be collected from the responsible party.

In the case of BGE-owned equipment, BGE will provide vandal proof equipment for select fixtures at the Customer's request and expense. If BGE identifies vandalism on BGE-owned equipment, BGE will make the Customer aware of the need for vandal proofing. If the Customer elects not to vandal proof the facilities, BGE has the option to remove the equipment for repeat cases of vandalism.

PRIVATE AREA LIGHT MAINTENANCE

The installation and ownership of an entire **private area lighting** system shall rest with either BGE or the Customer, at the Customer's option. In the latter case, BGE provides only the supply of electricity under Schedule G, GS, or GL. Where the private area lighting system is owned and maintained by BGE, the determination of type of facility as to overhead or underground rests solely with BGE.

Maintenance of BGE-owned lighting, including renewals, is performed by BGE within a reasonable period following notification by the Customer of the need for such service. Glassware is cleaned at the time of such maintenance. Permission is given to BGE to enter the Customer's premises at any time, for the purpose of inspecting and maintaining the lighting equipment. BGE reserves the right to deny the request for installation where access to the pole/fixtures is such that they could not be maintained using typical BGE supplied tools and equipment or maintenance could not be done without free access to the property.

Customers can call 800.685.0123 or go online at bge.com/outdoorlighting to report a light out and BGE will diagnose and fix the problem accordingly.

TEMPORARY STREET LIGHTNING

BGE, at their discretion, may provide temporary overhead street lighting to assist a municipality in illuminating a public roadway when permanent street lighting cannot remain in operable condition. The request for temporary street lighting begins by contacting a BGE Outdoor Lighting account representative to discuss project requirements. If an agreement is reached to move forward with BGE temporary street lighting, a completed Service Application for Street Lighting and Private Area Lighting Installation Projects and/or a formal written Municipal Request letter outlining the project requirements must be submitted to BGE (see Initiating a Street Lighting Job, page 7). In order for BGE to meet the temporary service date requested, please contact a BGE Lighting Account Representative as early as possible in the planning process.

Temporary street lighting will be designed, constructed, and billed for in the same manner as permanent street lighting. Temporary construction will be overhead in nature using a limited product selection. All temporary materials used will be owned, installed, energized, maintained, and removed by BGE. The customer will pay all labor costs involved with the installation and removal of temporary lighting equipment along with the monthly electric usage fees associated with the number and wattage of the lighting fixtures utilized. The customer is responsible for all damages to BGE-owned temporary lighting equipment as a result of construction. The installation and removal of BGE temporary street lighting will be worked and billed as two separate jobs. Therefore, a second Service Application for Street Lighting & Private Area Lighting Installation Projects and/or a formal written Municipal Request letter for removal of temporary equipment must be submitted when the temporary lighting is no longer required.

ENERGY EFFICIENT LUMINAIRE PRODUCTS

From our first transition of replacing gas with incandescent electric lighting, to more efficient high intensity discharge (HID) products, to the light emitting diode (LED) products (available in limited applications today), BGE Outdoor Lighting continues to stay true to our history of providing both the highest quality and energy efficient products available to our customers. We are constantly looking at new products and light sources that exceed existing performance, energy efficiency and environmental standards.

GENERAL INFORMATION

THE FOUR STAGES OF THE PROCESS

In order for the process to go smoothly and efficiently, it has been broken into four distinct phases:

- I. Initiation - Getting started
- II. Design - Preparing a detailed construction plan
- III. Site Readiness - Preparing the site
- IV. Construction - Installing lights and restoring the site

Each phase of the process includes requirements to advance to the next step. Promptly informing BGE of any changes will help minimize potential schedule delays or additional charges.

I. Initiation

Street Lighting

A. Initiating a Street Lighting Job

Lighting requests begin with a **completed** Service Application and/or a formal written Municipal Request letter. In order for BGE to meet the requested service date, please submit the Service Application and/or Municipal Request Letter as early as possible in the planning process.

To download the **BGE Service Application for Street Lighting & Private Area Lighting Installation Projects** visit bge.com/outdoorlighting.

Additional Information Required with the Service Application/Municipal Request

To ensure the proper processing of a lighting service application/municipal request, please include the following items:

- A **scaled site plan** with the following information included:
 - Minimum scale of 1" = 50'
 - All on-site utilities (private and/or public)
 - All structures and limits of paving outside the right-of-way (i.e., buildings, garages, lead walks, trails, etc.)
 - Road right-of-way (including limits of pavement, curb, sidewalk, driveway aprons, and street trees)
 - Site boundary
 - Lot lines, numbers, and address
 - Street names
 - Proposed light locations
 - Municipality seal of approval
- Letter of transmittal for approved street light plan or Request for Proposal
- Pole and light numbers for relocation, change, upgrade, or removal of BGE outdoor lighting equipment:
 - Include all wood pole metal tag(s) and/or yellow light location tag(s) on the required site plan (clearly marked with notations of what is to be done), or describe the work in the "scope of work" portion (under Q1b. Project Name) of the service application.
- Sketch with notations of project:
 - If you are unable to provide a site plan, please use the sketch area (located on last page of the application) indicating the requested lighting layout. The drawing should include the same basic information as a scaled site plan (i.e., street names, structures, proposed light locations or changes, etc.).

THE FOUR STAGES OF THE PROCESS (CONT'D)

Submitting a Service Application/Municipal Request Letter

Please package all documentation with the service application/municipal request letter and mail it to the address listed. A hard copy of the site plan may be submitted, or provide a disc in one of the following formats: MicroStation (all releases), AutoCAD (releases prior to Version 14), or .pdf.

Please mail the Service Application/Municipal Request Letter, and documentation to:

BGE – Customer Planning Department
Service Application Unit
1068 N. Front Street, Room 501
Baltimore, MD 21202

Upon receipt of the completed Service Application, BGE will provide a **WMS Job Number**, if requested, so customers can track the job from beginning to end online at bge.com/outdoorlighting.

B. Planning a Street Lighting Job

The planning process will begin after BGE receives a **completed** Service Application or Municipal Request Letter with an accurate description of the project, including the anticipated electrical requirements.

Step 1 Following receipt of the application/request letter, a BGE Lighting Account Representative may contact the customer to review job details and discuss the following:

- **Scope of Work** – ensures BGE understands the project and has all necessary information.
- **Job Information** – verifies project details, including the site plan.
- **Proposed Light Locations** – confirms locations as marked on the site plan. Customer designates the size and location of the fixtures and the location of the poles for streetlights. BGE will determine the type of system as to overhead or underground and location of the circuits.
- **Service Date** – sets an expected service completion date.

Step 2 BGE will evaluate and determine if the existing electric infrastructure is adequate to meet the lighting request. BGE will then develop an engineering plan or preliminary routing sketch proposing the work plan to meet the street lighting request.

- A site visit may be required to check clearances, discuss equipment details, and verify light locations.

***Step 3** BGE will estimate the job costs, labor and materials required to complete the project. BGE will determine the appropriate charges for the installation, and contact the customer with a job cost, if requested.

***Step 4 BGE will send a contract to the municipality or developer.** The contract will reflect the charges to have BGE complete the street lighting request. The contract will also show an estimated number of work days for BGE to complete the project.

***Step 5 Return the signed contract along with the agreed upon payment so BGE can proceed. The estimated number of work days for BGE to complete the job begins AFTER BGE's receipt of the signed contract and payment.**

Please mail the signed contract(s) and payment to:

BGE – Outdoor Lighting
Attention: **(BGE Outdoor Lighting account representative's name)**
1068 N. Front Street, Room 501
Baltimore, MD 21202

***Steps 3 – 5 will vary depending on the specific municipality's requirements.**

THE FOUR STAGES OF THE PROCESS (CONT'D)

Private Area Lighting

A. Initiating a Private Area Lighting Job

The customer's service request begins with a **completed** Service Application and/or a lighting request to BGE. In order for BGE to best meet the service date requested, please submit the Service Application as early as possible in the planning process. A BGE Lighting Account Representative will contact you to discuss your specific job requirements.

Download the **BGE Service Application for Street Lighting & Private Area Lighting Installation Projects** located on BGE's website at bge.com/outdoorlighting.

Additional Information Required with the Service Application/Private Area Lighting Request

To ensure the proper processing of the service application/private area lighting request, please include the following items:

- **A scaled site plan** with the following information included:
 - Minimum scale of 1" = 50'
 - All on-site utilities (private and/or public)
 - All structures and limits of paving outside the right-of-way (i.e., buildings, garages, lead walks, trails, etc.)
 - Road right-of-way (including limits of pavement, curb, sidewalk, driveway aprons, and street trees)
 - Site boundary
 - Lot lines, numbers, and address
 - Street names
 - Proposed light locations
- Pole and light numbers for relocation, change, upgrade, or removal of BGE outdoor lighting facilities:
 - Include all wood pole metal tag(s) and/or yellow light location tag(s) on the required site plan (clearly marked with notations of what you want done), or describe the work to be done in the "scope of work" portion (under Q1b. Project Name) of the service application.
- Sketch with notations of project:
 - Please provide a site plan, if filling out an application for BGE lights to be installed, removed, or replaced. If a site plan is not obtainable, please use the sketch area (located on last page of the application) indicating the requested lighting layout. The drawing should include the same basic information as a scaled site plan (i.e., street names, structures, proposed light locations or changes, etc.).

Submitting a Service Application

Please package all additional documentation with the service application and mail it to the address listed. A hard copy of the site plan may be submitted, or provide a disc in one of the following formats: MicroStation (all releases), AutoCAD (releases prior to Version 14), or .pdf.

Please mail the Service Application and documentation to:

BGE – Customer Planning Department
Service Application Unit
1068 N. Front Street, Room 501
Baltimore, MD 21202

THE FOUR STAGES OF THE PROCESS (CONT'D)

Upon receipt of the completed Service Application, BGE will provide a **WMS Job Number**, if requested, so customers can track the job from beginning to end online at bge.com/outdoorlighting.

B. Planning a Private Area Lighting Job

The planning process will begin after BGE receives the customer's **completed** Service Application or request with an accurate description of the project, including the anticipated electrical requirements.

Step 1 Following receipt of the application/request, a BGE Lighting Account Representative will contact the customer to review job details and discuss the following:

- **Scope of Work** – ensures BGE understands the project and has all necessary information.
- **Job Information** – verifies project details, including the site plan, if applicable.
- **Proposed Light Locations** – confirms locations as marked on the site plan, if applicable. Customer designates the size and location of the fixtures and the location of the poles for private area lights. BGE will determine the type of system as to overhead or underground and location of the circuits.
- **Service Date** – sets an expected service completion date.

Step 2 BGE will evaluate and determine if the existing electric infrastructure is adequate to meet the lighting request. BGE will develop an engineering plan or preliminary routing sketch proposing the work plan to meet the private area lighting request.

- A site visit may be required to check clearances, discuss equipment details, and verify light locations.

Step 3 BGE will send the customer a monthly contract for lights. The Private Area Lighting monthly contract is a lease of lighting equipment. At the end of the initial contract term, billing continues on a month to month basis until the contract is terminated by at least 30 days notice by the Customer or BGE. Pricing is not locked in by signing a contract, rather pricing is bound by provisions of BGE's Electric Retail Tariff, Schedule PL, which can be found at bge.com/outdoorlighting.

In addition, an Extension/Relocation Contract (ERC) covering any upfront costs for the project may be required. Upfront costs may include, but are not limited to, transformers, trenching methods, concrete bases, traffic protection, shields, and custom charges.

The monthly lease rate includes all installation costs not covered by the Extension/Relation Contract (ERC), the equipment, maintenance, and all energy costs. Billing will begin once installation is complete.

Step 4 Return the signed contract(s) along with the agreed upon payment so BGE can proceed with designing the job.

Please mail your signed contract(s) and payment to:

BGE – Outdoor Lighting
Attention: **(BGE Outdoor Lighting account representative's name)**
1068 N. Front Street, Room 501
Baltimore, MD 21202

Please note that additional charges may apply if BGE is required to deviate from original plan or standard practices and procedures. For example: design revisions, multiple designs, job scope changes.

THE FOUR STAGES OF THE PROCESS (CONT'D)

II. Design

- Step 1** After BGE receives a signed contract and payment, a BGE designer will contact the customer to confirm the initial project information is still accurate.
- **Responsible person** - Confirm who the responsible parties for managing the customer's project are: owner, construction superintendent, and who, if anyone, is authorized to sign the final design print, besides the owner.
 - **Detailed utility site plans** - Confirm that BGE has the final plans, showing where easements, property lines, and other on-site utility lines are located: fuel, water, sewer, telephone, electric, geothermal systems, etc. This facilitates design turn-around time, and minimizes the possibility of changes later. **Please notify BGE immediately if any detail of your plan requirements change.**
- Step 2** BGE will prepare a detailed lighting construction design, including the specific plans needed for BGE construction crews to perform the work.
- The following categories may require additional input from BGE in order to define the final design:
 - Duct systems which may interface with existing urban distribution duct systems (Baltimore City Department of Public Works).
 - Hand box application.
- Step 3** BGE will send a copy of the Final BGE Design Drawing to the customer, if requested.
- Step 4** For Private Area Lighting projects, return the signed design drawing, any right-of-way agreements, and any remaining payment due.
- Full payment must be received before construction work will be scheduled.**
- Step 5** BGE will apply for utility permits required for the installation of BGE facilities. The time this takes varies, depending on the location and type of permit. On average, the standard utility permit requires 4-8 weeks for approval; however, some permits may take longer.

Any changes subsequent to the execution of the contract, such as significant changes in connected load, voltage class, transformer and meter location, or inadequate site conditions will delay work and **may result in additional costs** for re-engineering, design, and/or construction and will delay the service date.

III. Site Readiness

A. Site Conditions

- Step 1** If applicable, customer ducts, manholes, and transformer pads must be installed as shown on the signed BGE Design plan and in accordance with BGE specifications.
- Step 2** Please comply with the following agreed-upon site preparation for BGE equipment:
- Site must be within 6 inches of final grade.
 - Install and mark in 3 foot intervals: water, sewer, storm drain, and all other non-BGE utilities.
 - Locate and clearly mark all private underground facilities on private property. Examples include: well water line, septic field, private lighting, underground sprinkler system, invisible fence wires, etc.
 - Clear the site of all building materials, trees, stumps, and other obstructions along the route of the proposed BGE facilities.
 - Locate and clearly mark proposed property/curb lines on the job site.
 - Locate and clearly mark proposed transformer locations.

THE FOUR STAGES OF THE PROCESS (CONT'D)

- Install transformer pads and conduits with pull strings (minimum of 500 psi).
- Home is under finished roof.
- Curb, gutters, sidewalk, and driveway installed.
- Light locations clear of debris and properly marked.
- Jobsite is clear for lighting supply cable installation.

IV. Construction

All personnel working on the installation of BGE outdoor lighting equipment are trained and certified. If a BGE-approved contractor does the construction work a BGE inspector will monitor quality control on the site.

A. Construction

- Step 1** If needed, a BGE contractor crew leader will visit the site to check site conditions. In preparation for Miss Utility, crews may pre-mark the ground of the intended outdoor light equipment installation area with white paint.
- Step 2** BGE will call Miss Utility to have the outdoor lighting installation area marked for public utilities. BGE may elect to call a private locator service, at BGE's expense, to have some locatable private utilities marked. It is **always** the customer's responsibility to mark **all** of their private utilities in the white painted area before BGE crews start outdoor light equipment installation. BGE will not be held responsible for the repair of unmarked private utilities damaged during outdoor light equipment installation.
- Step 3** BGE's installation contractor and inspector will coordinate a start installation date before the published complete construction date. Prior to installation, outdoor lighting equipment may be delivered by tractor trailer truck to customer's facility.
- Step 4** During installation of underground lighting equipment, BGE may need to dig test holes or remove utility access covers within the general work area to verify the depth and location of existing underground utilities to avoid damage to them during construction. BGE will perform restoration of these areas.
- Step 5** **Stay Clear!** While BGE installs the outdoor lighting equipment heavy equipment may be moving around the job. Construction equipment may be left overnight. Holes and trenches may be open during construction for splicing and testing. All trenches and holes will be clearly marked with safety cones and/or safety fencing.

A note about customer safety: Please keep a safe distance from the active construction area. If there are concerns and the customer cannot, at a safe distance, get the attention of the crew leader working on site or the BGE inspector at his next visit, please contact a BGE Outdoor Lighting account representative.

B. Site Restoration

- Step 1** **BGE will restore the customer's property.** During construction, BGE minimizes disturbing established earth and pavement, wherever practical.
- Step 2** Once construction is complete, BGE will mend the affected areas of the customer's property as promptly as possible.
- If sidewalk or roadway sections are removed, temporary paving may be necessary. Permanent paving will be completed shortly after the temporary pavement has been poured.
 - During winter months, permanent paving may be postponed until suitable conditions exist.
 - Existing earth will be restored. If the installation work is done in the winter, BGE will return in the spring—a more suitable time for site restoration.

THE FOUR STAGES OF THE PROCESS (CONT'D)

National Electrical Safety Code (NESC)

BGE Outdoor Lighting Systems are designed to National Electric Safety Code (NESC). Because of the NESC utility grade design differences from the National Fire Protection Association (NFPA) 70 and the National Electric Code (NEC) used by electricians, only BGE certified personnel can perform installation and maintenance services on energized NESC supply cable.

Luminaires and poles are installed and maintained as dictated by the type of outdoor lighting service selected by the customer and approved by BGE, based on Schedules SL and PL of BGE's Electric Retail Tariff. Visit bge.com/outdoorlighting for more information.

Additional Guidelines for Plan Layout and Site Preparation for Developers

- BGE must receive an approved, recorded lot plan drawing, and the location of all other underground utilities detailed. This information should be provided at the Initiation Phase for street lighting and private area lighting.
- If the project is to be developed in sections, the developer must provide a master plan drawing that details the total area to be developed, including the location of all future streets and a proposed schedule for construction.
- The developer must provide site preparation in the following manner prior to the installation of BGE facilities:
 - Grade all underground electrical easements and street rights-of-way within 6 inches of the final grade.
 - Identify all required boundaries and provide lot corner pins and lot number stakes for all lots.
 - Provide radius stakes for all curved portions of streets where electric cables will be installed.
 - Provide a level area at final grade for all transformers and have location staked.
 - Execute the proper right-of-way agreements prior to selling any lots.

Customer may submit a hard copy of the site plan, an electronic file on disk, or a CD-ROM in an approved format:

- Microstation-(.dgn)(all releases)
- AutoCAD-(.dwg) (all releases)
- .pdf format

Files may be sent to the address listed or e-mailed to the BGE outdoor lighting account representative assigned to the project.

BGE – Customer Planning Dept.
Service Application Unit
1068 N. Front Street, Room 501
Baltimore, MD 21202

Questions? A BGE Outdoor Lighting account representative is available to answer questions throughout this process at **410.470.9446 (toll free 800.685.0123)**. Please have available the WMS Job Number, Site Name and Address when you call.

IMPORTANT INFORMATION AND RESPONSIBILITIES

Access to BGE's Lighting Equipment

BGE requires that the customer grant permission for the installation, operation, inspection, maintenance and replacement of Outdoor Lighting equipment, including poles, fixtures, anchors, wires, cables, and other equipment, on the customer's premises. BGE has the right, at all times, of ingress and egress over customer's land to access this equipment, and to remove said equipment.

Location of Gas & Electric Transmission Facilities On or Adjacent to Rights-of-Way

The developer shall locate all gas and electric transmission rights-of-way (fee simple and easement) across, or adjacent to the property to be developed. Any existing access to the gas and electric rights-of-way across the property to be developed must be identified and maintained. Proposed improvements on or near transmission rights-of-way, or any impact to access, shall be submitted to the Real Estate Specialist within the Real Estate Unit for review prior to finalization of the site design. For further information, call **410.470.6706**.

Permissions and Rights-of-Way

By requesting installation of BGE Outdoor Lighting, customers give BGE permission to install main or secondary line extensions on the customer's property. BGE may require a signed right-of-way agreement. If additional rights-of-way across other properties are required to bring service to the customer's property, it will be the customer's responsibility to acquire them and pay for any additional costs to obtain them. (BGE will assist by providing standard forms.)

Our standard right-of-way agreement allows BGE to place equipment along and adjacent to lot lines, driveways, and other physical features. Installations along front lot lines are normally within 10 feet of the lot line, and installations along-side lot lines are normally within 5 feet of side lot lines.

Installation of Ducts in Advance of Paving

If the customer must pave prior to the installation of BGE Outdoor Lighting, the customer has the option to install duct or pay for directional boring at BGE's proposed cable crossings. A BGE Lighting Account Representative will provide preferred locations for these crossings. Installations of ducts are the customer's responsibility. For more information on conduit and duct installation, see Customer Installation of Conduits (page 23) and Road Crossing Specifications (page 28).

Vaults and Manholes

If the customer's street lighting project requires building to or accessing existing vaults, transformer vaults, or manholes, please refer to the BGE Conduit Construction Information Booklet at **bge.com**.

Limitations on Lighting Installations and Extensions

Outdoor Lighting will be supplied only where, in the opinion of BGE, adequate source and return on investment is available or can be made available under the provisions of BGE's Electric Retail Tariff.

Customer Additions and Alterations

Under no circumstance may any customer/builder, municipal or private, alter or add load to any BGE owned equipment.

Relocation of BGE Lines and Equipment

If the lighting project requires that gas and/or electric mains or service need to be relocated, a BGE representative will determine which infrastructure requirements apply.

The customer is responsible for indicating where all private infrastructures are located (sprinkler systems, electric dog fences, low-voltage garden lighting, geothermal systems, etc.), and for clearing the path of construction.

Relocations are charged at 100% of estimated installed costs and are subject to Gross-Up for Federal and State taxes that are imposed on the company.

IMPORTANT INFORMATION AND RESPONSIBILITIES (CONT'D)

Customer's Responsibility to Cooperate with BGE

The charge provisions for outdoor lighting installations are predicated upon cooperation by the customer in an effort to keep BGE's cost as low as possible. Additional costs resulting from the customer's failure to cooperate, such as the paving of roads, parking areas or driveways prior to the installation of BGE's outdoor lighting facilities, shall be borne by the customer.

Additional costs for non-standard construction will be billed to the customer, builder, or municipality.

National Electrical Safety Code Clearance Requirements

The National Electrical Safety Code requires specific distances between utility facilities, such as overhead lines, and other structures, such as buildings, decks, and pools. The distances vary based on the types of utility facilities and structures being put up. It is the customer's responsibility to determine the distance requirements and abide by them. Failure to do so creates a dangerous situation that can be costly for the responsible party to remedy later.

Maryland High Voltage Line

The Maryland High Voltage Line Act (HVLA) sets a 10-foot safety zone around overhead utility lines. Individuals and equipment are strictly prohibited within the safety zone. The customer must contact BGE prior to starting any work in the safety zone at 800.685.0123. Any person who violates any provision of the High Voltage Line Act is subject to a fine, imprisonment, or both.

If work must be performed within 10 feet of an overhead utility line, with prior notice and approval, BGE will initiate proper safety measures, including:

- Relocating the lines.
- Installing physical barriers to prevent any contact with the lines.
- De-energizing and grounding the lines.
- Other proactive safety steps.

While it is BGE's goal to help the customer work safely around overhead utility lines, BGE is not required to bear any expense for any safety measure required by the High Voltage Line Act.

For more information about the Maryland High Voltage Line Act (HVLA) visit bge.com.

Private Property Owner Responsibilities for Private Area Lighting Installations

Contact a BGE Lighting Account Representative who will work with you to formulate an acceptable concept for submittal to BGE. The representative will prepare a PAL contract for review, approval, and signature by the private property owner.

Builder/Developer Responsibilities for Private Area Lighting Installations

In advance of zoning review, contact a BGE Lighting Account Representative who will work with you to formulate an acceptable concept for submittal to BGE. Please provide billing information so that the representative can prepare a PAL contract for review, approval, and signature by the builder/developer.

Builder/Developer Responsibilities for Street Lighting Installations

- In advance of zoning review, contact a BGE Lighting Account Representative who will work with you to formulate an acceptable concept for submittal to BGE.
- Submit, on builder/developer letterhead, the municipal project tracking number, name, and road intersections. Itemize the requested street light equipment and services in the body of the letter.

IMPORTANT INFORMATION AND RESPONSIBILITIES (CONT'D)

- Provide an approved and signed street light installation design print to scale with numbered stake locations, street light schedule, light source, wattage, pole location, type and height, arm length and aim, and any shading. Existing BGE pole numbers should also be included in this drawing.
- Understand and adhere to Schedule SL of BGE's Electric Retail Tariff, which can be accessed at bge.com/outdoorlighting.
- Make the street light installation site ready for BGE. This includes brush and tree trimming and removal prior to streetlight equipment installation.

BGE Responsibilities

- Contact the customer once a completed Service Application is received.
- Conduct initial site visit for planning and designing job, if needed.
- Furnish and install outdoor lighting equipment per extension/relocation contract or private area lighting contract.

Municipality Responsibilities

- In advance of zoning review, contact a BGE Lighting Account Representative who will work with you to formulate an acceptable concept for submittal to BGE.
- Submit, on municipality letterhead, an authorization letter with project tracking numbers, name and road intersections, and BGE grid number. Itemize the requested street light equipment and Schedule SL services in the body of the letter.
- Provide an approved and signed street light installation design print to scale with numbered stake locations, street light schedule, light source, wattage, pole location, type and height, arm length and aim, and any shading. Existing BGE pole numbers should also be included in this drawing.
- Understand and adhere to Schedule SL of BGE's Electric Retail Tariff, which can be accessed at bge.com/outdoorlighting.
- Make the street light installation site ready for BGE. This includes brush and tree trimming and removal prior to streetlight equipment installation.

Controlled Supply of Electricity

- **Street Lighting:** Under item 1 of the Monthly Rates, the Company makes available a controlled supply of electricity for operation of the lamps from dusk to dawn each night for a total of approximately 4,000 hours per year. When at the Customer's request, and agreed to by the Company, the Company provides customized lighting control, such that the lights burn for less than the stated hours per year, no adjustment to the monthly fee will be made for reduced electricity usage, because service under the Scheduled is unmetered.
- **Private Area Lighting:** Supply to Company-owned lamps is controlled by the Company for operation from dusk to dawn each night for a total of approximately 4,000 hours per year. When, at the Customer's request, and agreed to by the Company, the Company provides customized lighting control, such that the lights burns for less than the stated hours per year, no adjustment to the monthly fee will be made for reduced electricity usage, because service under this Schedule is unmetered.

RETAIL ELECTRIC SERVICE TARIFF

Outdoor lighting service is provided by BGE under the terms of the Electric Retail Tariff, Schedules SL and PL. The tariffs define lighting availability as well as ownership and maintenance options and provisions. Monthly rates for products and services are included.

Street Lighting (Schedule SL)

Street Lighting, Schedule SL is available for unmetered street lighting service supplied from overhead or underground facilities on dedicated public streets and roads where required by City, Town, County, or other Municipal or Public Agency, or by an incorporated association of local residents. A builder or developer may contract for street lighting service prior to the execution of a contract with the ultimate customer.

For overhead supplied lighting, BGE will provide, own, and maintain all equipment as listed and priced under the tariff.

For underground supplied lighting, various options for ownership and maintenance are available. Please refer to the current Schedule SL tariff.

Private Area Lighting (Schedule PL)

Private Area Lighting Schedule PL is available for unmetered outdoor area lighting of private property. It covers the lighting of, among other things, recreation and park areas, parking lots and storage areas as required by residential, commercial, industrial, and farm customers, and public agencies such as schools, hospitals, and libraries. It also covers the lighting of non-dedicated roadway systems such as those in garden-type apartments, condominiums, mobile home parks, and government agency properties.

Under Schedule PL, BGE installs, owns, and maintains the entire private area lighting system. Additionally, the customer may contract equipment listed in the Schedule and which are standard items stocked by BGE.

BGE's Retail Electric Service Tariff, Schedules SL and PL can be found at bge.com/outdoorlighting.

LIGHTING SPECIFICATIONS AND ILLUSTRATIONS

SAMPLE CUSTOMER SITE PLAN FOR LIGHTING

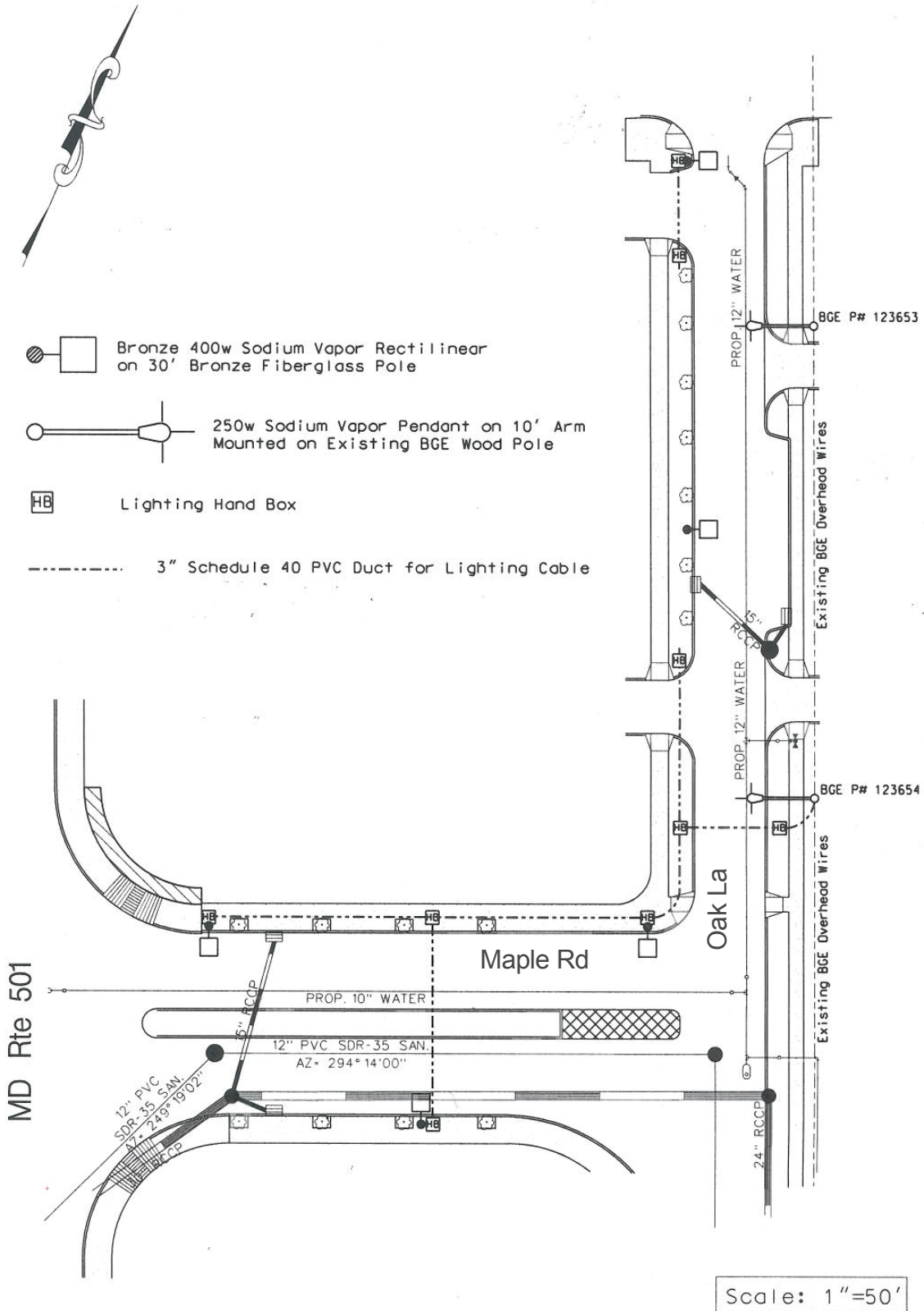

STREET TREE PLACEMENT – GENERAL GUIDELINES

In order to assure adequate visibility of signs and vehicles, and to prevent the blocking of street lights, street trees shall not be placed:

- Within 100 feet of the face of a STOP or YIELD sign;
- Within 50 feet of the face of any other street sign;
- Within 25 feet of a street light; or
- Within 150 feet of the intersection to the left or within 100 feet of the intersection to the right along a cross street at an intersection controlled by a STOP or YIELD sign.

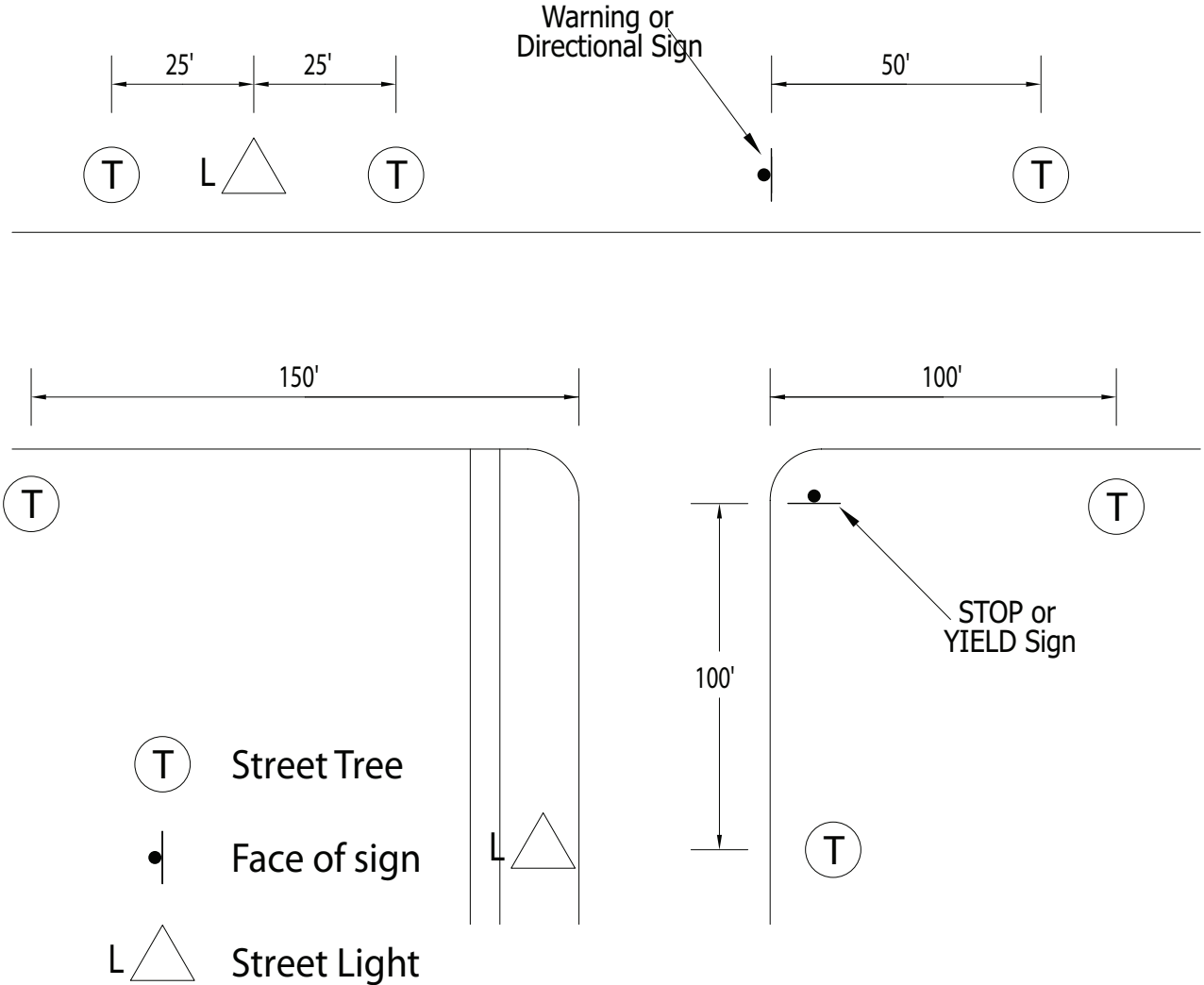

STREET LIGHT POLE LOCATIONS

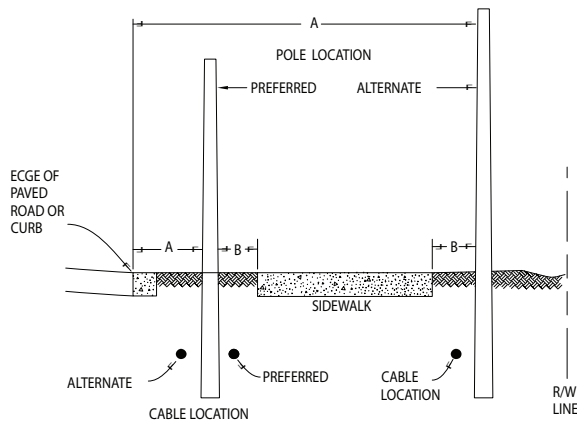

CURBED AND UNCURBED PUBLIC AND PRIVATE ROADS

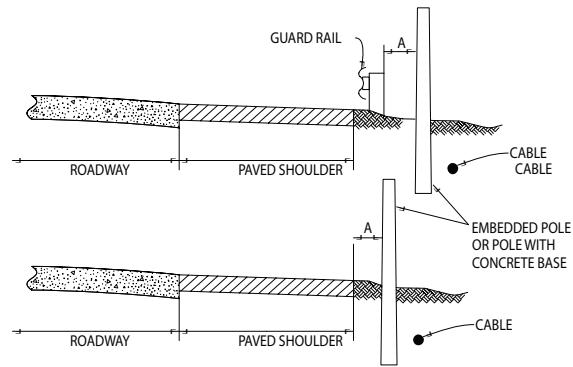

UNCURBED ROADS WITH PAVED SHOULDERS

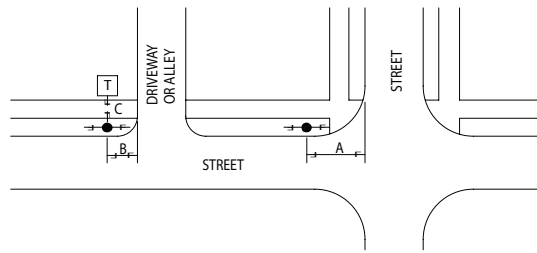

- — PLACEMENT OF STREET LIGHT FOR PROPER ORIENTATION OF LIGHT PATTERN
- A — APPROXIMATE END OF CURB RADIUS MIN. 10ft
- B — MIN. 5ft FROM DRIVEWAY OR ALLEY
- C — MIN. 10ft FROM PAD-MOUNTED TRANSFORMERS OR OTHER METAL STRUCTURES

	DISTANCE FEET	CURBED STREETS NOTE (1)		UNCURBED STREETS (NO PAVED SHOULDERS) NOTE (1)		UNCURBED STREETS (PAVED SHOULDERS) NOTE (1)	
		A	B	A	B	A	
PUBLIC RESIDENTIAL STREETS	MIN.	1-1/2	1	5 (2)	1	-	
	PREF.	2-1/2	-	5 (2)	-	-	
	MAX.	10	-	10 (2)	-	-	
PRIVATE AND OTHER ROADS WITH HEAD-IN PARKING	MIN.	5	1	5 (2)	1	-	
	PREF.	5	-	5 (2)	-	-	
	MAX.	10	-	10 (2)	-	-	
ARTERIAL ROADS, STATE HWYS. IND. PARKS	MIN.	5	1	5 (2)(3)	1	2 (2)(3)	
	PREF.	5	-	5 (2)(3)	-	2-1/2 (2)(3)	
	MAX.	10	-	10 (2)(3)	-	-(2)(3)	

Notes:

1. Street light customer may specify distance not less than min. or more than max.
2. Pole should be placed min. 2 ft. from drainage ditches.
3. State or county regulations may require greater setback, but installation and maintenance conditions should be considered when complying.

TRAFFIC PROTECTION (BOLLARD/CONCRETE POLE BASE)

BGE will assist the customer in choosing light locations that provide optimum illumination levels while keeping the general public and BGE's equipment out of harm's way. It is sometimes necessary to install lighting equipment in areas where damage from vehicular traffic is a concern. In such cases, specific products such as bollards and concrete bases are required to provide adequate protection.

BGE can install the protection devices for a fee, or the customer may provide them at their expense. BGE regulations and standards will apply to the construction and placement of such devices in either case.

Note: If traffic protection devices are to be installed by the customer, it is your responsibility to call Miss Utility before digging.

Due to the varied and unique lighting locations that many jobs require, it is always best to work with a BGE Lighting Account Representative to identify the proper scope of protection that is required. Pole placement, traffic density and landscape conditions are just a few of the issues that must be addressed when considering whether traffic protection devices will be required.

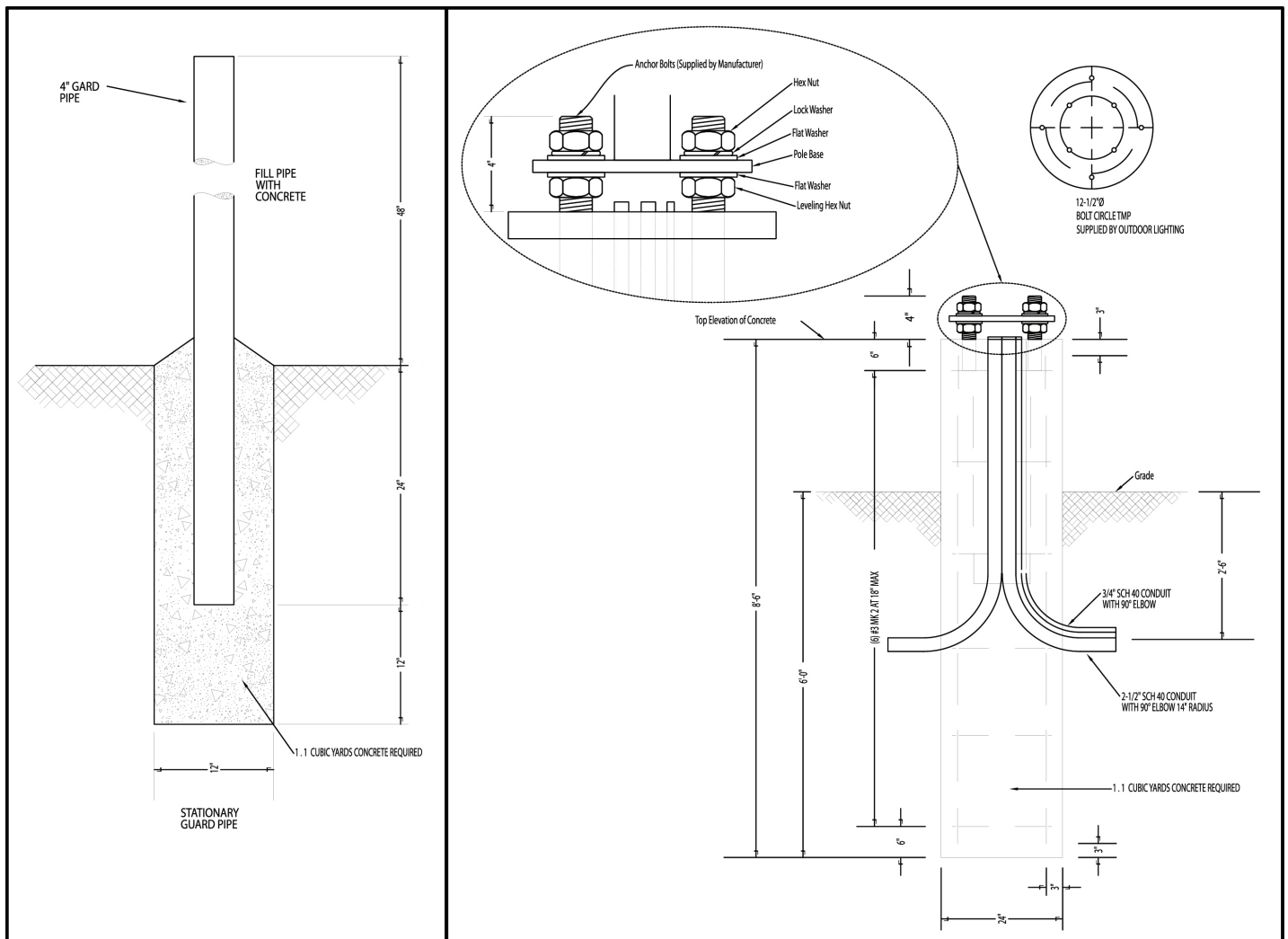

CUSTOMER INSTALLATION OF CONDUITS

Certain hardscape and roadway improvement projects require that BGE-owned lighting supply cable be installed in a customer designed, built, owned, and maintained duct system. BGE will provide a schematic duct plan showing only connectivity between the electric sources, proposed hand boxes, and the proposed and/or existing street light poles and luminaires. Exact duct routes between points are to be determined by the customer, dependent upon existing obstructions and field conditions, as well as the final placement of the street lighting poles.

Lighting Supply Conduits

1. Conduit will be 3 inches minimum inside dimension I.P.S.
2. Application dependent, conduit meeting the following specifications is acceptable for use on BGE's system: UL Schedule 40, EB-35, DB-60, DB-120, ANSI/ASTM F-512.
3. Bends shall be no less than 36 inches in radius and limited to one 90-degree change in direction. A total of two 90-degree bends are allowed in the conduit line (i.e., conduit turn-up at transformer pad is one 90-degree bend). One additional, wide-radius bend (minimum radius of 5 feet for this additional bend) will be allowed. If this still will not be sufficient for the conduit design/construction, contact your BGE representative. A hand hole, splice box, or manhole may be required.
4. Concrete Encasement:
 - Duct banks must be concrete-encased if any conduits are stacked vertically (one on top of the other). All 2x2 duct banks and greater must be concrete encased.
 - All bends must be concrete encased to prevent duct separation during cable installation.
 - Virgin soil/select backfill is allowed for all other conduit installations.
 - Only standard 2,000-psi ready-mix concrete with air entrapment and pea gravel will be approved for encasement.
 - Ducts within Baltimore City right-of-way: Contact the Department of Public Works.
5. For proofing of duct, the customer shall pull a mandrel (1/2-inch smaller in diameter than the conduit and 6 inches long) through each duct prior to BGE cable installation, followed by a 1/2-inch pull-in cord (500 lb. minimum tensile strength), which shall remain in each duct. Duct termination shall be plugged with pulling lines installed and location markers placed to facilitate BGE's location and use of it.
6. Customers will connect all EB (encased and buried) and DB (direct buried) electric conduits with sealed/glue couplings.
7. Customers will terminate their conduit with bell ends and plugs.
8. Slope of ducts shall prevent flooding of transformer and hand boxes.
9. Required depth of conduits from final grade to top of conduit/conduit bank is 24 inches for lighting supply cable.
10. Lengths of lighting supply duct banks shall be minimized to limit pulling distances and electrical losses. Any secondary duct lengths over 100 feet shall be approved by BGE prior to construction.
11. The minimum longitudinal separation between foreign structures and conduit should be as follows:
 - Telephone/Cable Television Conduit—3 inches of concrete or 12 inches of earth
 - Gas, Water, Sanitary and Oil Mains—12 inches of earth
12. Splice boxes, pull boxes, or manholes may be required by BGE depending on the specific installation.
13. Duct turn-ups at BGE electric distribution supply poles shall be installed according to the instructions provided with the Conduit Pole Connection illustration on page 27.
14. Inspection of duct installation and witnessing of duct proving shall be the responsibility of the customer.

CUSTOMER INSTALLATION OF CONDUITS (CONT'D)

Hand Box - General Installation Detail

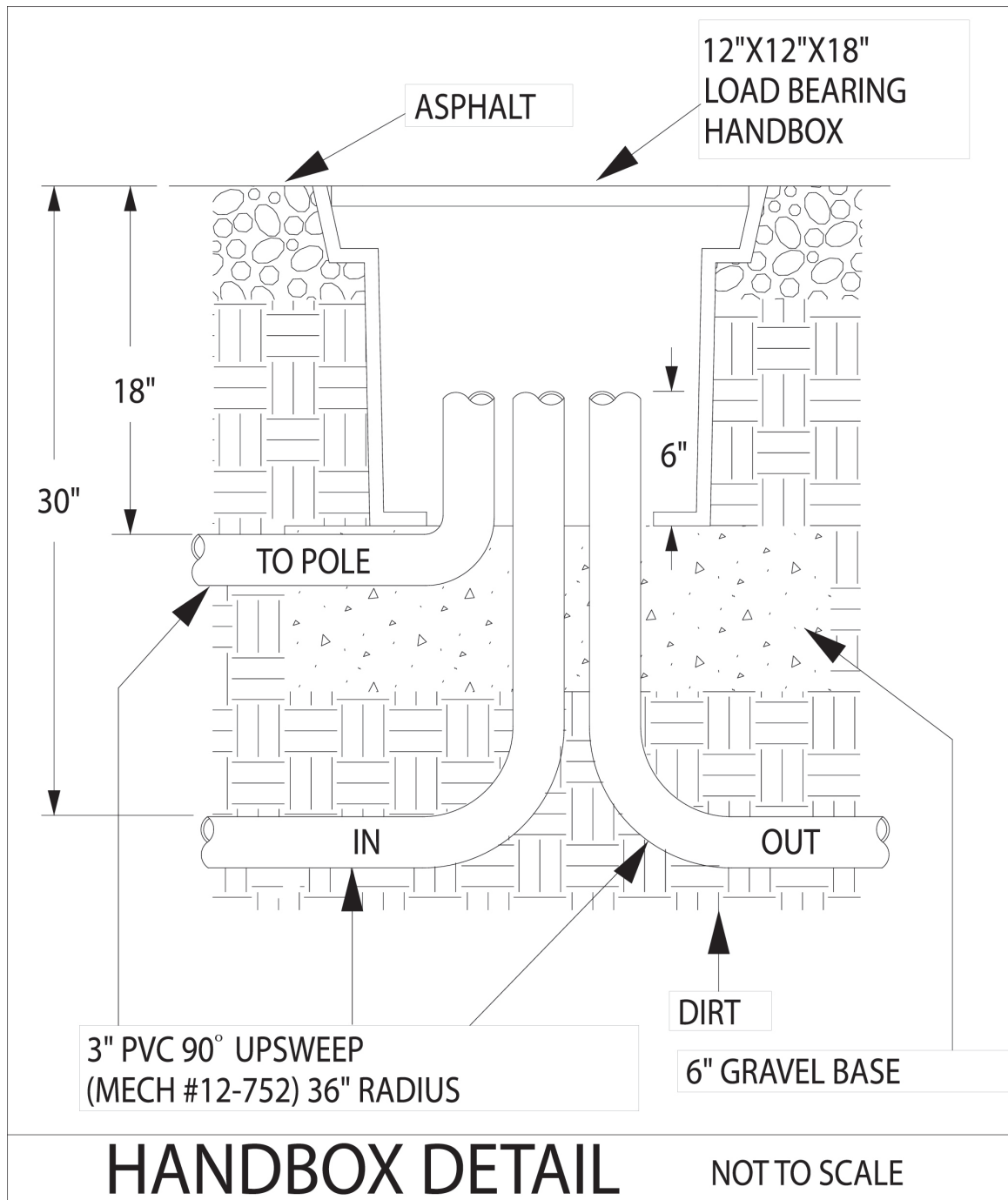

CUSTOMER INSTALLATION OF CONDUITS (CONT'D)

Hand Box - Sidewalk Application

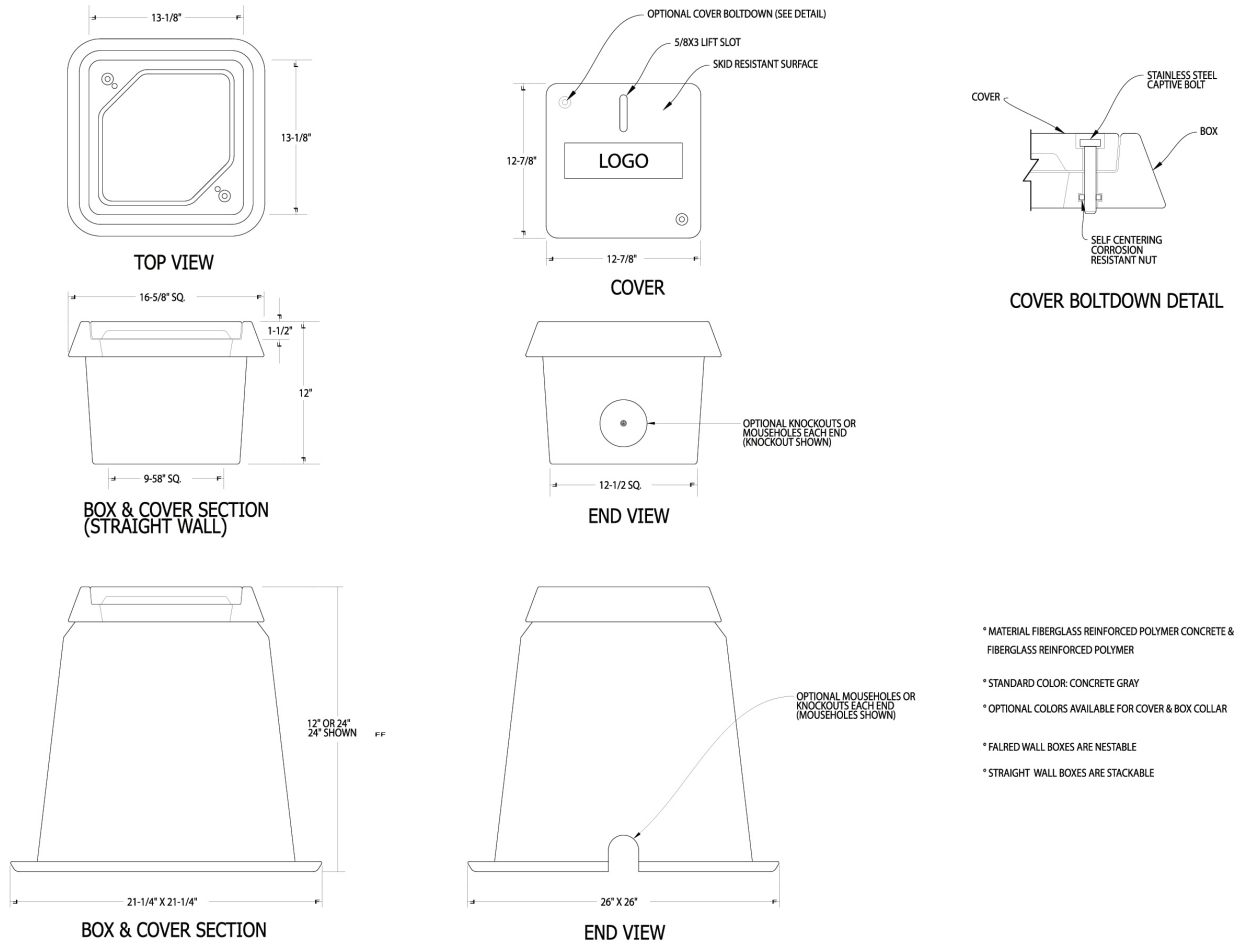

Installation Guidelines

1. Prepare the excavation.
 - a. Excavate approximately 10 inches greater around the actual outside dimension of the enclosure to be installed and 6 inches deeper than to depth will be required for installation.
 - b. Add 6 inches of gravel or crushed rock for drainage.
2. Place enclosure in hole – top of enclosure should be at grade level.
3. Fill and compact soil – fill to grade level with cover in enclosure.

Preferred Method for Cutting Holes in CDR Enclosures

1. Drill a 7/8" pilot hole with a carbide tipped drill.
2. Drill hole using a hole saw. A diamond tipped hole saw will be able to cut more holes than a regular hole saw.
3. Holes cut in the enclosure should not exceed more than 25% of the area of each sidewall and should not be cut into a structural reinforcing rib, corner, or box lip.

CUSTOMER INSTALLATION OF CONDUITS (CONT'D)

Hand Box - Grass/Dirt Application

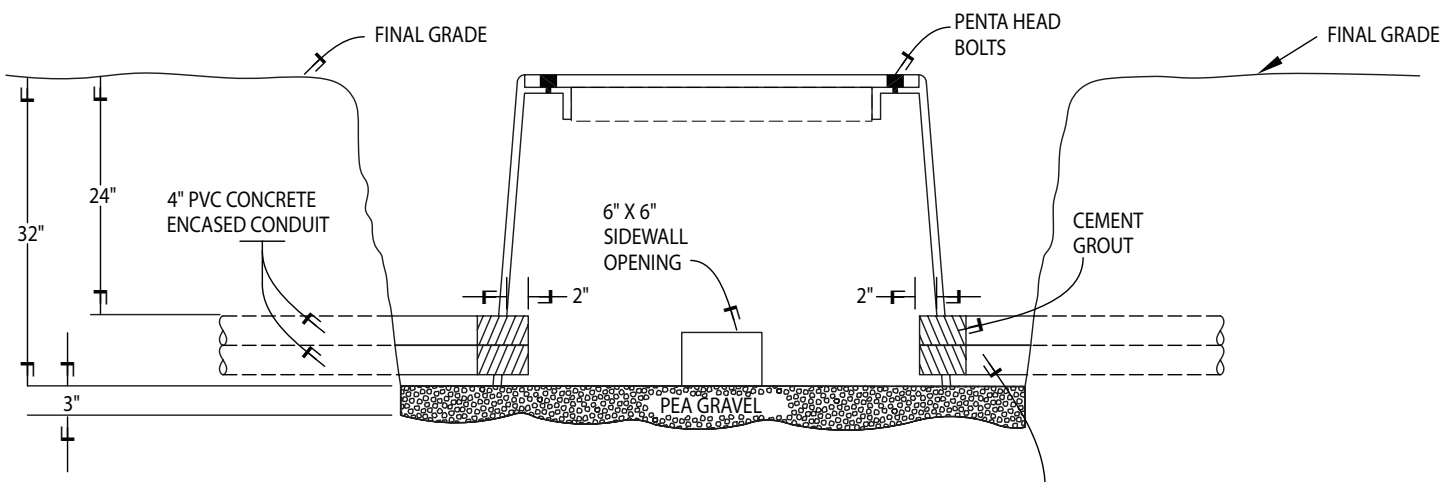

FIBERGLASS SPLICE BOX
(MAT'L NO. 12-647)
PROVILE VIEW

NOTE:

UP TO A MAXIMUM OF SIX 4-INCH DIAMETER
DUCTS CAN EXIT THE FIBERGLASS SPLICE
BOX'S EXTENDED OPENING OF 16"W X 10"H

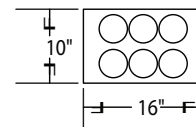

General Information

1. This fiberglass splice box must be installed only in pedestrian (grassy) areas on level ground. It must not be installed on a hill or slope.
2. Excavate an area 5'W x 6'L x 35" deep (minimum) for the splice box.
3. Stabilize the bottom of the excavation with 3" of pea gravel. The bottom flange of the splice box must be on a firm level foundation.
4. Position the enclosure in the excavation so that the cover will be flush with final grade.
5. Ducts can only enter and exit the splice box at opposite ends from each other. When necessary, the existing 6" x 6" openings in the end walls can be enlarged to accommodate multiple ducts (maximum opening 16"W x 10"H). This enlarged opening will allow up to six 4" diameter ducts (3W x 2H configuration) to enter or exit this box. However, only a maximum of eight ducts can be joined to this splice box at any time, one for the secondary main and up to seven for the service cables.
6. Install the ducts no more than 2" into the splice box. Place cement grout around the ducts on the outside of the splice box to seal openings.
7. Place a block of wood over side wall openings without ducts, on the outside, to prevent backfill from entering the confines of the splice box.
8. Backfill evenly around the splice box with clean, dry earth. Mechanically tamp in 12" layers.
9. Install fiberglass cover and secure its position with pentahead bolts.

CUSTOMER INSTALLATION OF CONDUITS (CONT'D)

Conduit Pole Connection

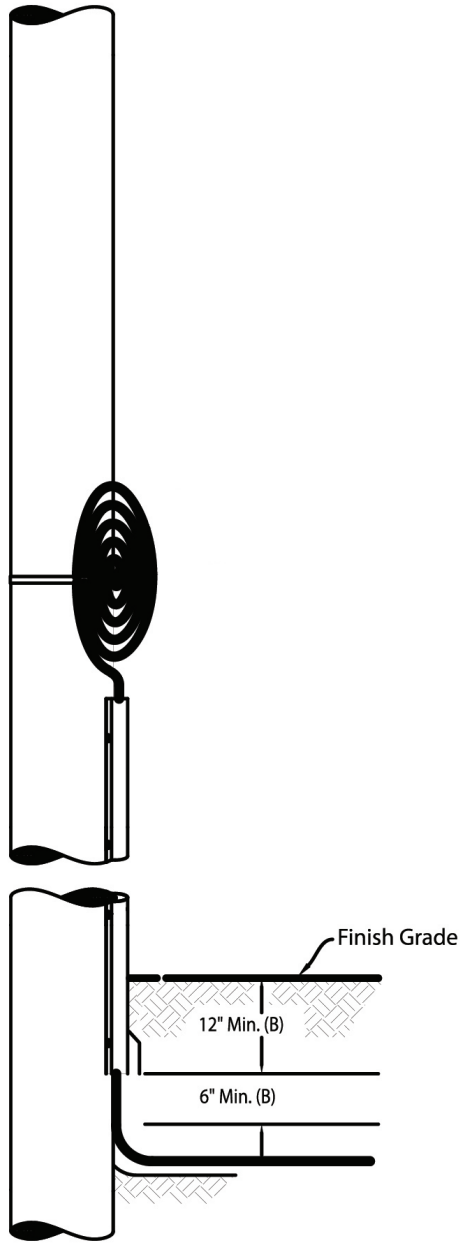

Direct Buried Cable

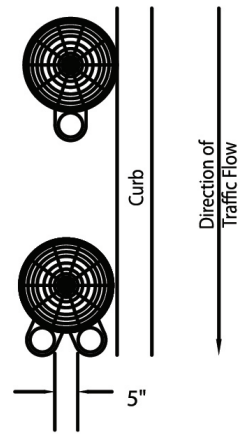

Riser Location

CUSTOMER INSTALLATION OF CONDUITS (CONT'D)

Road Crossing Specifications

NOTE: For street lights, 3" conduit may be used in place of 4½" conduit

- NOTES:
- A minimum 12" radial separation must be maintained between gas and any other utility.
 - Allow a minimum 6" separation between primary ducts or between primary and secondary ducts.
 - Place an electronic marker 12" above the end of the PVC duct crossing(s).

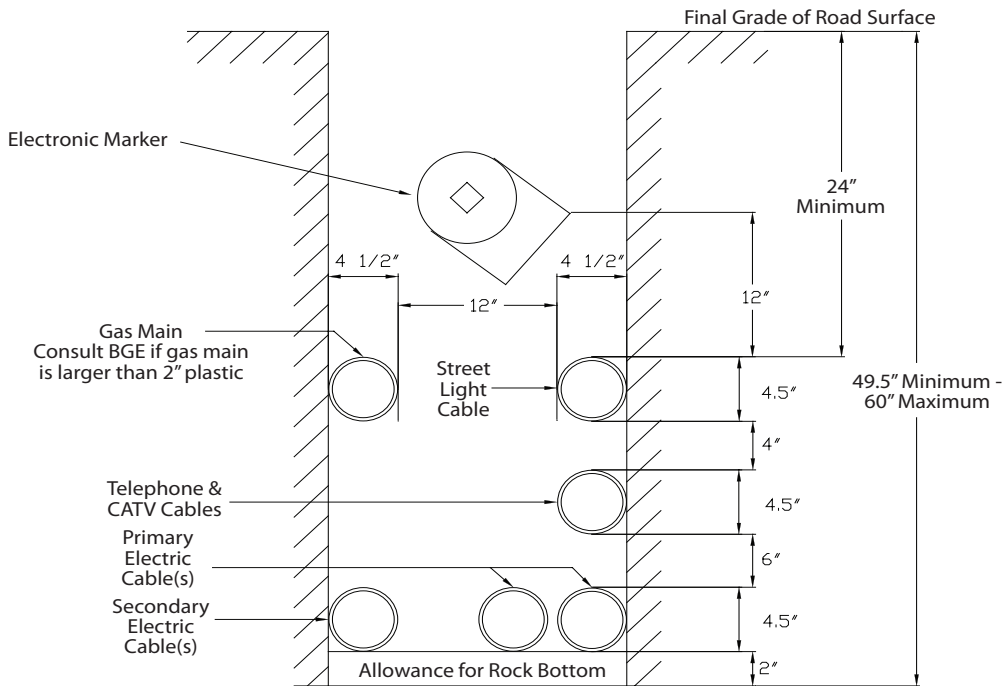

- NOTES:
- All ducts to be 4" PVC SCH 40 unless otherwise noted. Ducts must extend a minimum 5' beyond proposed paving.
 - Place an electronic marker 12" above the end of each PVC duct crossing(s).
 - Install a PVC duct plug on the end of each duct crossing(s).

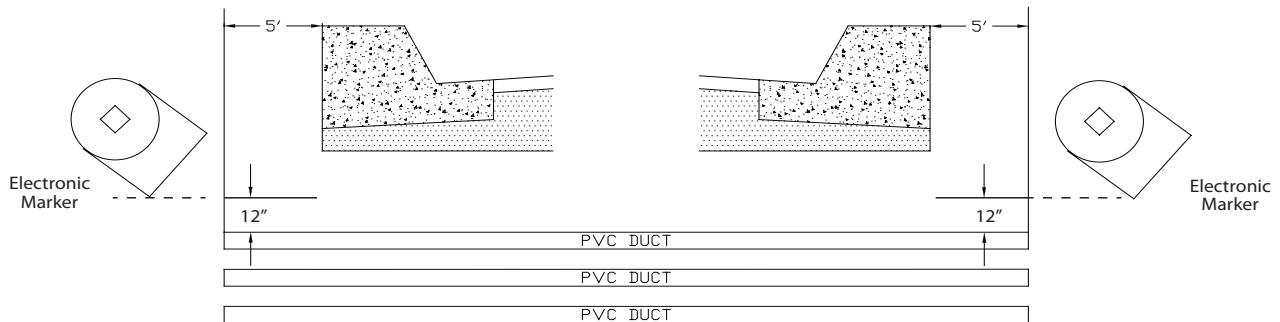

PAD MOUNTED TRANSFORMERS

Transformer Location Requirements

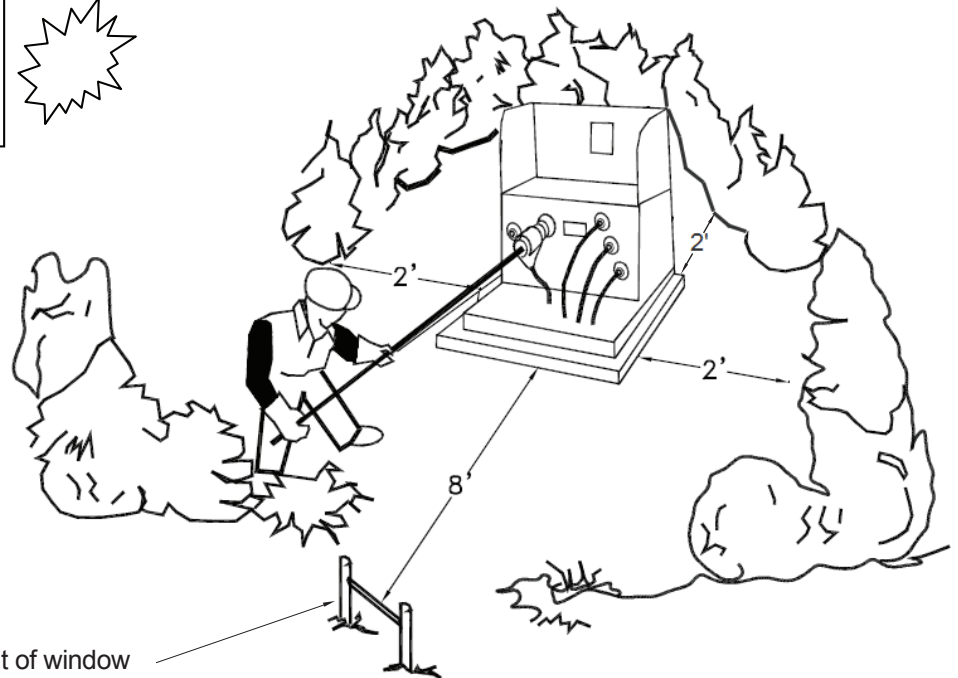
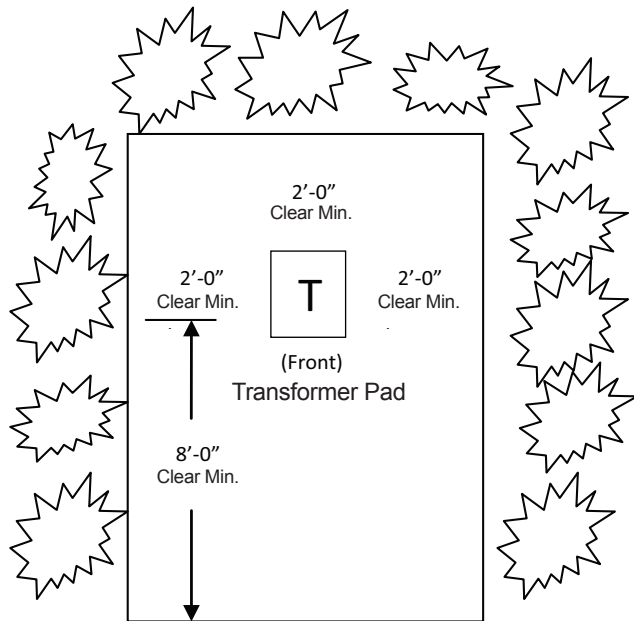

Note:
8' from any obstruction in front of window

Note: Minimum clearances are from the edge of mature plants, not from the stem of planting stock.

The transformer pad shall be installed on a level, compacted area with a minimum of 8 feet of clear and level operating space in front of the transformer pad. Obstructions cause delays when restoring electric service and WILL BE REMOVED.

PAD MOUNTED TRANSFORMERS (CONT'D)

Transformer Location Guidelines – Single Phase Residential Development

BGE's basic design policy for Underground Residential Distribution (URD) is established for economics, accessibility, inspection, maintenance, operations, and minimum interference with customers. Primary cables are buried in the right-of-way between customer's front property line and roadway edge. Equipment is placed on private property 6 feet from the front lot line.

Between adjacent properties:

Transformer pad will be centered between adjacent properties.

Road right-of-way:

The front face of the transformer pad will be set back 6 feet from property line (road right-of-way).

Driveway:

A minimum of 3 feet 6 inches must be between the transformer pad and a driveway.

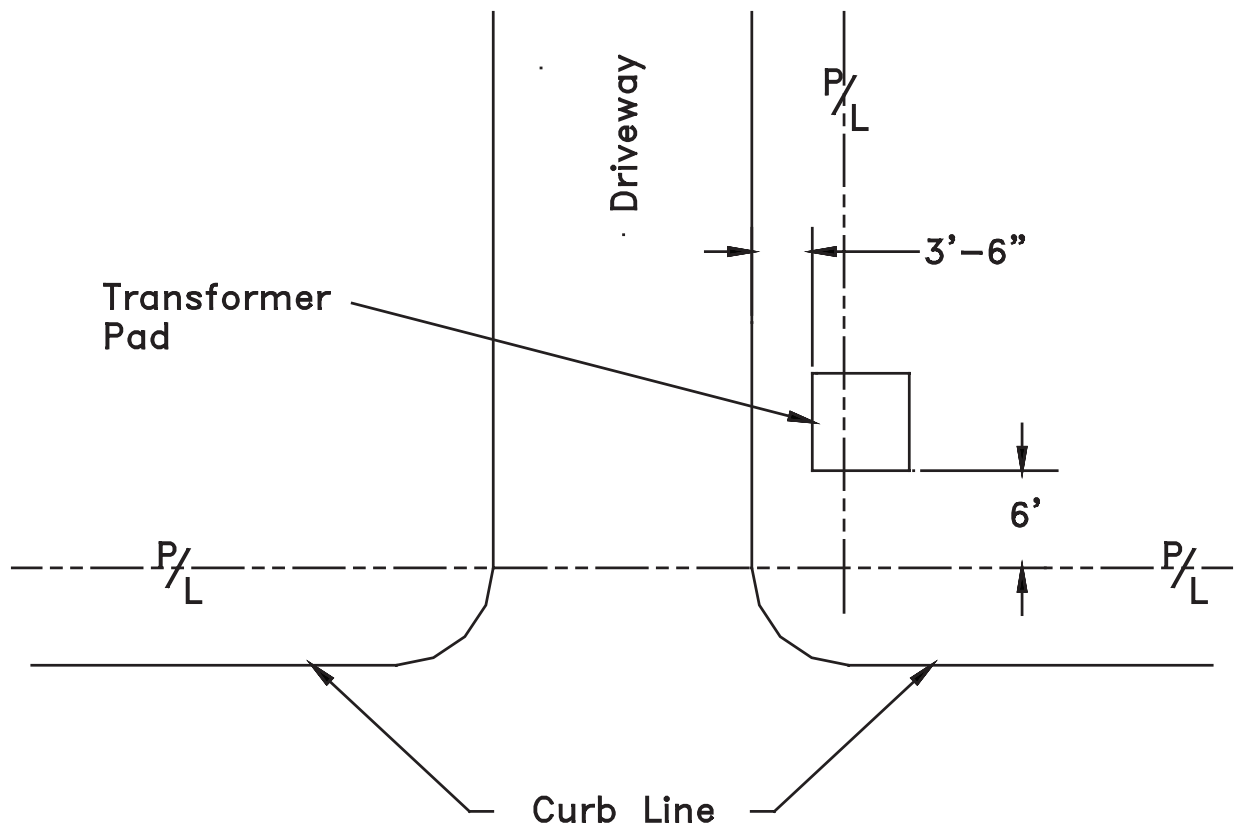

PAD MOUNTED TRANSFORMERS (CONT'D)

Transformer Location Guidelines – All Other Pad Mounted Equipment (Switchgear, 3 Phase Transformers, Capacitors, etc.)

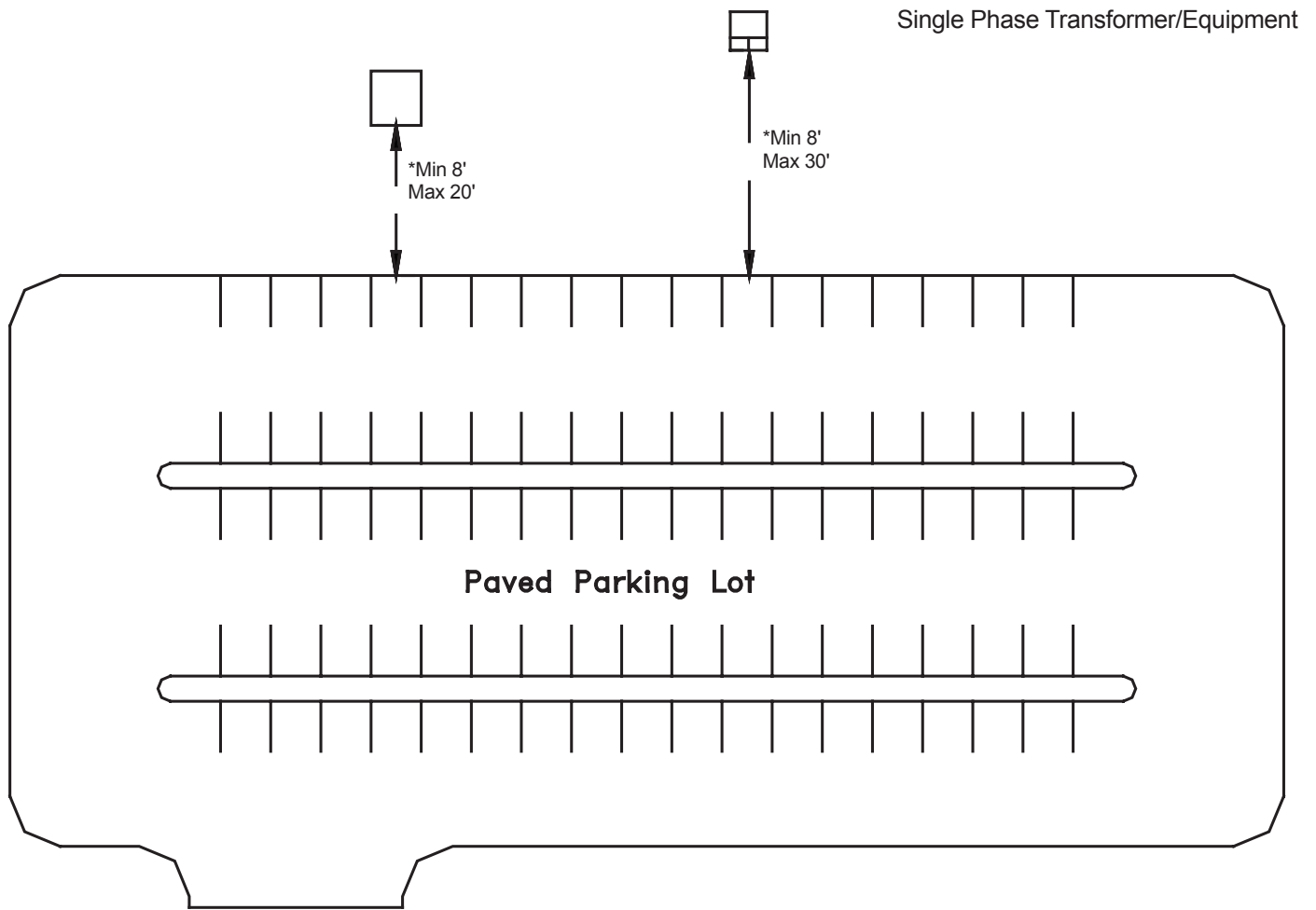

* Transformers shall be protected on all sides exposed to vehicular traffic or within 8 feet or less from roadways and parking lots.

PAD MOUNTED TRANSFORMERS (CONT'D)

Transformer Location Requirements

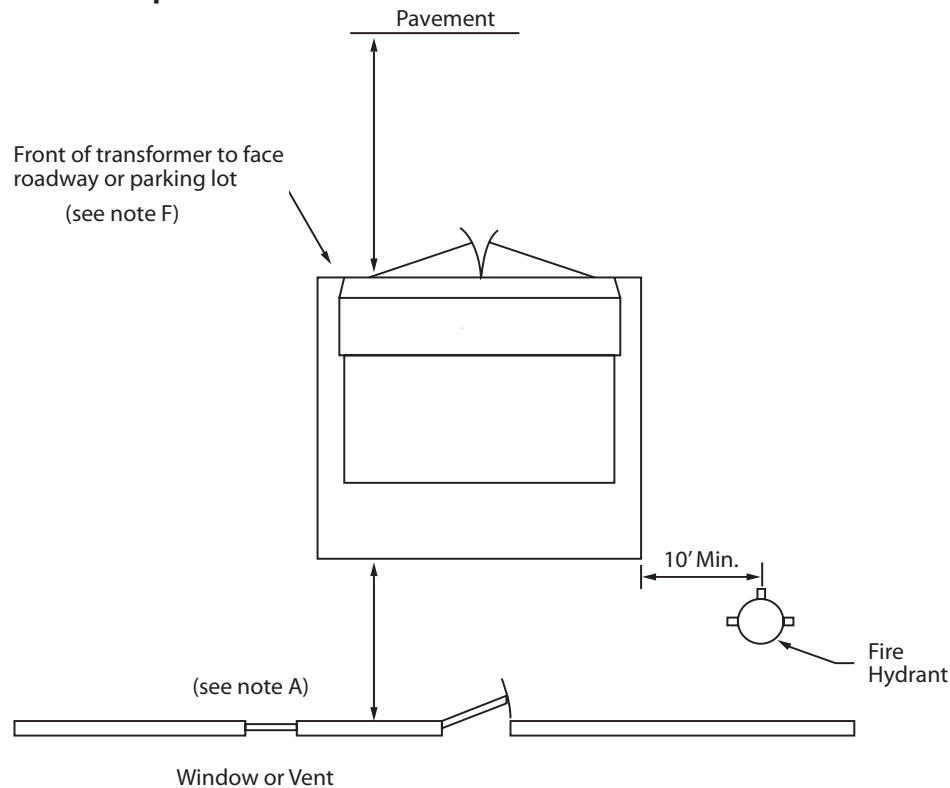

- A.** 2 feet minimum to masonry fire resistant walls of building with no openings.

20 feet minimum to any flammable building wall. A minimum diagonal distance of feet from top of transformer is required if placed beneath window unless barrier wall is constructed according to BGE standard. (Standards can be supplied.)

20 feet minimum on any opening in a building wall including: doors, windows, ventilating exhaust, intake ducts, or any fire escape.

- B.** Transformer to be no further than 20 feet (30 feet. for single phase) from a paved access road to allow for vehicular access for future transformer/cable maintenance.
- C.** Traffic protection is required on all sides of transformer that are within 8 feet of roadway or parking lot.
- D.** The above are minimum clearances between the transformer foundation and window, doors, fire escapes, entrances and ventilation ducts. It shall be the customer's responsibility to see that the applicable National Electric Code, municipality and/or insurance regulations and requirements are met.
- E.** Transformer location must have a 5 foot horizontal clearance from underground facilities.
- F.** Transformer may be positioned so the primary and secondary cables do not cross when customer duct installation is required.

Storm water runoff shall be directed away from transformers and other equipment. Transformers shall also be placed to prevent flooding of the building and/or electrical conduits. Transformers and conduits shall never be placed so that they drain towards a building, unless adequate drainage and run-off protection has been installed.

Transformer shall be placed on a level, compacted area with a minimum of 8 feet of clear and level operating space in front of the transformer pad. The access road/paving area must be capable of supporting the weight of a 15 ton vehicle.

PAD MOUNTED TRANSFORMERS (CONT'D)

Transformer Location Requirements (cont'd)

A) Preferred Method – This location provides a clearance between the building and transformer.

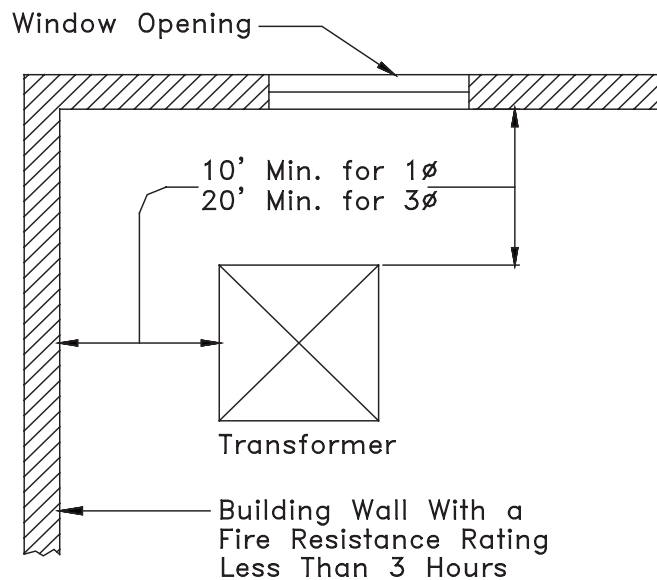
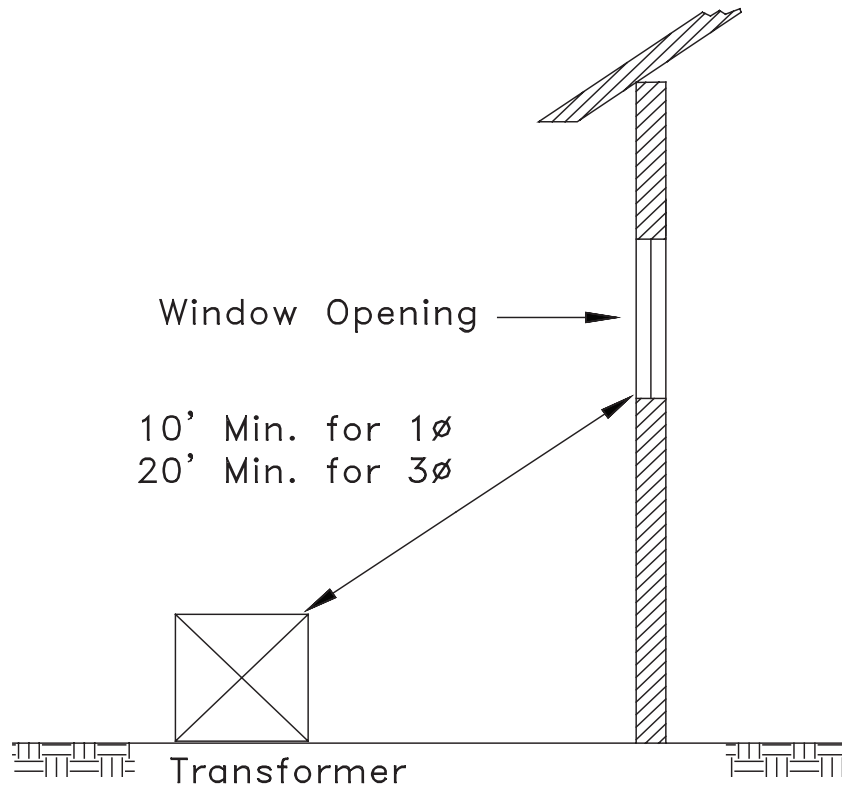

PAD MOUNTED TRANSFORMERS (CONT'D)

Transformer Location Requirements (cont'd)

B) Alternate Method – When the preferred clearance cannot be achieved, transformer units may be placed closer if fire resistive construction is provided. Exposed building components within the reduced clearance shall provide the following protection:

- Walls: a minimum fire resistance rating of 3 hours
- Doors: class A, fire resistance rating of 3 hours
- Eaves: eliminated or fire-proofed
- Windows: eliminated or filled with 3 hour fire rated material
- Other wall openings: same as windows or doors
- Fire escapes: protected by 3 hour fire rated material

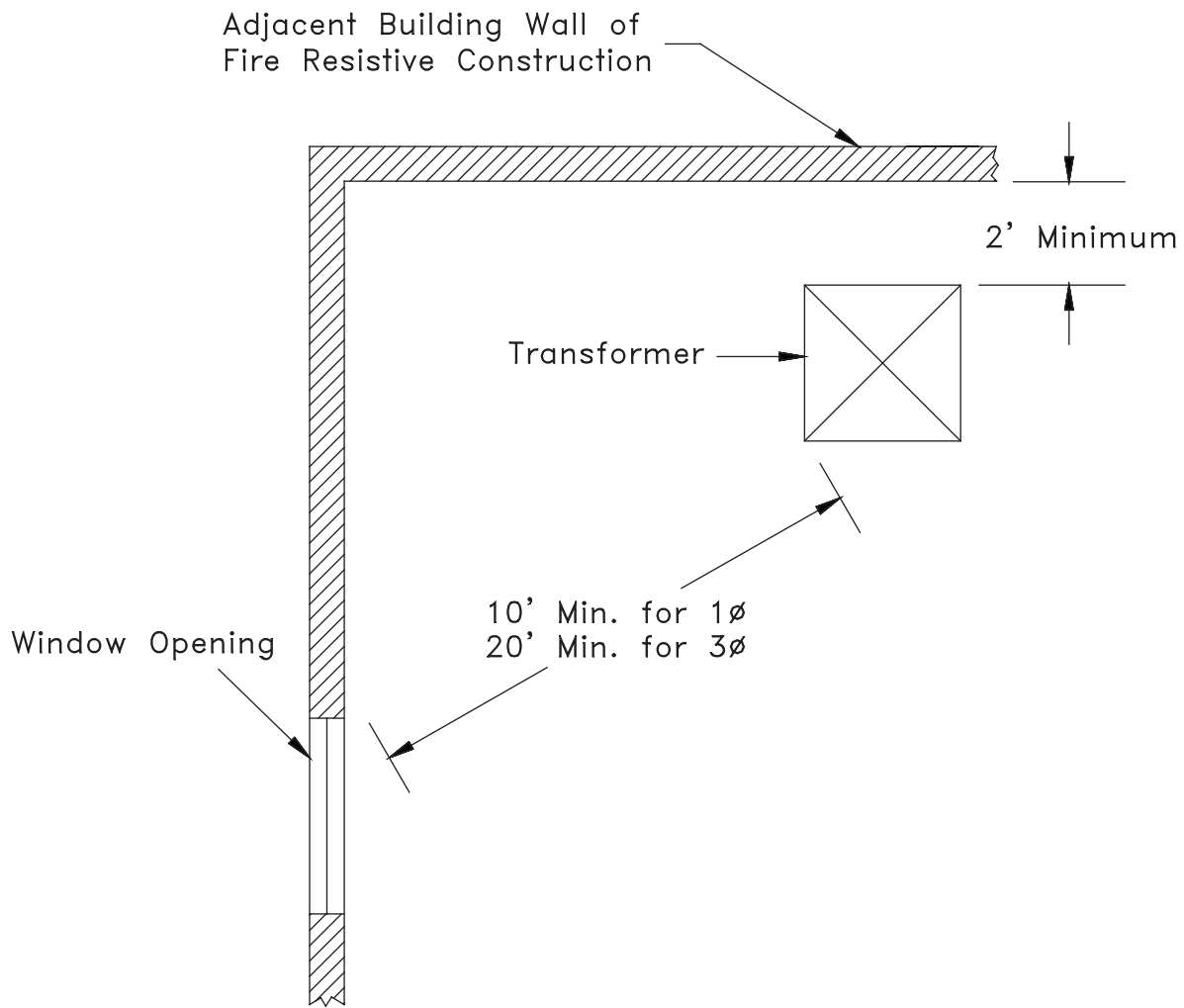

PAD MOUNTED TRANSFORMERS (CONT'D)

Transformer Location Requirements (cont'd)

C) **Alternate Method** – When the preferred clearance cannot be achieved and altering the building is undesirable, construct a barrier wall as shown. Barrier walls must meet the following requirements:

- Be separate from the building
- Have a fire resistance rating of 3 hours
- Protect all exposed combustible building components within the minimum distance specified in the Preferred Method
- Be constructed in one of the following ways:
 - a. Eight inches of brick (two courses)
 - b. Four inches of reinforced concrete
 - c. Eight inches of concrete block
 - d. Twelve inches of hollow tile

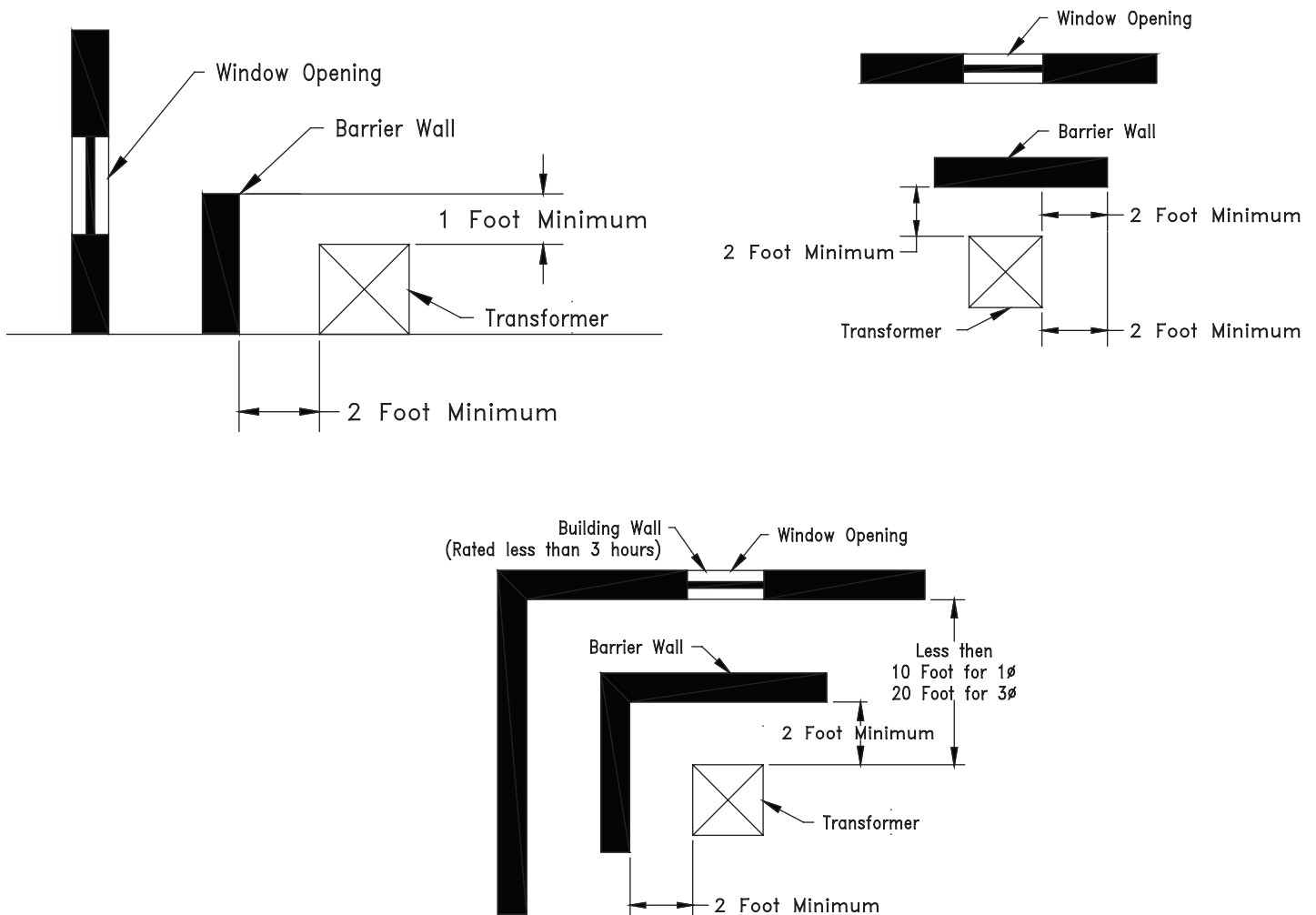

PAD MOUNTED TRANSFORMERS (CONT'D)

Transformer Pad Specifications

Customers are responsible for purchasing and installing the transformer pads for three-phase transformers. Pre-cast concrete transformer pads can be purchased and delivered to your site from BGE's Contractor Supplier by contacting 302.292.2660.

- Two different pads are available:
 - BGE Material No. 12-668 for use with transformers 500 kVA and smaller
 - BGE Material No. 12-790 for use with transformers 750 kVA and above
- BGE allows "pour in place" transformer pads, in accordance with the specifications.

Note: A sump may be required under transformers that contain more than 300 gallons of oil (750 kVA or larger). The 40' diameter sump (to 72" below grade) is required if the final grades will slope toward an adjacent building.

This is especially true if the area around the transformer is to be paved and drains installed. Contact the BGE Representative for the project to determine the final details of design and construction.

- The front of the transformer pad should be placed in such a way as to prevent the crossing of primary and service ducts. This simplifies the installation and maintenance of conduits.
- The pad shall be installed on a level area with a minimum of 8 feet of clear and level operating space in front of the transformer pad. BGE is responsible for the grounding of the transformer pad.
- The customer shall install the ground rod when the pad is installed on the site. If no space is being left in the pad opening, a PVC duct shall be installed to exit the pad side to allow for a grounding connection.
- If the duct count exceeds nine, the ducts shall be banded together within the transformer pad cutout to ensure all ducts remain in their correct spaces within the transformer.

DEFINITIONS & FREQUENTLY ASKED QUESTIONS

DEFINITIONS

Ambient Light - The general overall lighting in an area.

Approach Main - Extensions of mains necessary to reach the boundary of a residential subdivision, industrial park, shopping center, a commercial or industrial property on which multiple buildings are to be located, or a single residential or commercial building lot.

Ballast - A device used to operate fluorescent and HID lamps.

BGE - Baltimore Gas and Electric Company or an employee properly qualified to represent Baltimore Gas and Electric Company.

Bollard - A concrete filled steel pipe, set in a concrete footer, to protect BGE equipment from vehicular damage.

Brightness - Strength of the sensation that results from viewing surfaces from which the light comes to the eye.

C & I - Commercial and Industrial.

Color Rendering - Effect of a light source on the color of objects in comparison with their color under normal daylight.

Concrete Enclosed Duct Bank - Structure consisting of duct(s) spaced at a pre-determined distance from each other and enclosed in concrete.

Conduit - A structure containing one or more ducts.

Conduit System - Any combination of duct, conduit, conduits, manholes, handholes, and vaults joined to form an integrated whole.

Connected Load - The amount of electrical power used by any electrical unit or appliance.

Customer - Any present or prospective user of BGE's gas or electric service, or any person or entity representing him, such as the architect, engineer, electrical contractor, land developer, builder, etc.

Cutoff Angle - Angle measured up from nadir (i.e. straight down) to the point which one can first view the bare light source (lamp).

Cutoff Fixture - A fixture, which provides a cutoff (shielding) of the emitted light.

Dark Adaptation - The process by which the eye becomes adapted to low levels of light.

Developer - Party responsible for constructing and providing improvements in a development, e.g., streets, sidewalks, and utility-ready lots.

Development - Planned project which is developed by Developer/Applicant in a recorded plot plan of one or more lots for construction of single-family residences, detached or otherwise, mobile homes, or apartment houses, all of which are intended for year-round occupancy.

Disability Glare - Glare that impairs the ability to see detail without necessarily causing visual discomfort.

Discomfort Glare - Glare that causes visual discomfort without necessarily impairing the ability to see detail.

Distribution System - The mains, services, regulating and metering equipment, and appurtenances used to distribute gas or electricity from the source of supply to customers.

Doubtful Permanency (Service) - A service intended for two years or less, such as for construction, exhibit, or carnival purposes. The temporary facility will be removed at the completion of its use.

Dry mix concrete - One part concrete to two parts gravel that when mixed with four parts water will provide a "Concrete 1-2-4 mix."

Duct - A single enclosed raceway for conductors or cable.

Efficacy - The ability of a lighting system to produce the desired result.

Efficiency - A measure of the useful output of a system or fixture compared to the input of the system.

Footcandle - Measurement of the illuminance produced on a surface, 1' x 1'.

Full Cutoff Fixture - Fixture that allows no light emission above a horizontal plane through the fixture.

Glare - The discomfort or impairment of vision experienced when parts of the visual field are excessively bright in relation to the general surroundings.

Ground - A conducting connection between an electrical circuit or piece of equipment and the earth, or to a conducting body that serves in place of the earth.

HID - High Intensity Discharge.

High Pressure Sodium (HPS) - HID lamp with high lumen package but poor color rendering.

Illuminating Engineering Society (IES) - Professional society of lighting engineers, manufacturing companies, and others professionally involved in lighting.

DEFINITIONS (CONT'D)

Improved Areas - Areas that have landscaping, lawns, or paved surfaces.

Lamp – Source of light, a device to convert electric energy into visible radiant energy.

Light Emitting Diode (LED) - Semiconductor device that emits light by releasing energy in the form of photons.

Light Pollution - Any adverse effect of man-made light. Often used to denote urban sky glow.

Light Trespass - Light falling where it is not wanted or needed. Spill light or obtrusive light.

Lumen - Measurement of light, one footcandle is one lumen per square foot.

Luminaire - Device which directs, controls or modifies the light produced by the lamp. Consists of the lamp, optical system, electrical and mechanical components and decorative parts.

Main - That part of a line which is located: (a) along a street or road which is a public highway used as a thoroughfare by the general public, and (b) along a private road or across private property and used for the supply in common of at least two separately metered buildings.

Maryland High Voltage Line Act (HVLA) - Maryland law establishing a 10-foot safety zone around overhead utility lines.

Metal Halide - HID lamp with a white/blue light output. Best lamp for color rendering.

Meter - If used without other qualification, any device that is used by a utility to measure a quantity of gas or electricity.

Multiple Occupancy Building - A unified structure containing five or more individual dwelling units.

National Electrical Safety Code (NESC) - Industry-accepted safety standard for overhead and underground electric utility and communications utility installations.

Photometrics - A geometric representation of the luminous intensity of a light source at a given distance.

Point of Connection - In general, that point where facilities installed by BGE are connected to the customer's facilities.

- a. The point of connection for overhead secondary services is at the service head on the customer's building or structure and adjacent to the first point of attachment of the service drop to the building or structure.

- b. The point of connection for underground secondary services including URD from underground mains is (1) for outdoor meter locations—at the meter mounting equipment, or 2) for indoor meter locations—just within the building wall at the point where the service run enters the building or at the splice box just outside the building.

Preliminary Routing Sketch - An engineering plan showing BGE's proposed route of construction, and transformer and meter locations as drawn on the customer's site/utility plan.

Premise - A tract of land or real estate, including buildings and other appurtenances on it.

Quality of Light - Subjective ratio of the pluses to the minuses.

Readily Accessible - Capable of being reached quickly for operation, maintenance, or inspections, without requiring those for whom ready access is a requisite to climb over or remove obstacles or to resort to portable ladders, chairs, etc.

Reflector - Controlling light output and distribution by means of reflection.

Refractor - Controlling light output and distribution by means of refraction lens' plastic or glass.

Residential Service - Gas and/or electric service supplied exclusively for domestic purposes in individually metered dwelling units, where permanent residency is established, including the separately metered non-commercial use facilities of a residential customer (e.g., garages, water pumps, etc.).

Secondary Service - Service metered at nominal voltages of 600 volts or less.

Semi Cutoff Fixture - Fixture that provides some cutoff, but less than a cutoff or full cutoff.

Service - The conductors and equipment that deliver energy from BGE's system to the wiring or piping system of the premise being served. It also means maintenance of voltage, frequency, and gas pressure (within acceptable tolerances) by BGE at the point of delivery.

Service Drop - The overhead conductors from BGE's last pole or other aerial support to and including the splices, if any, connecting the customer's service entrance conductors at the building or other structure.

Service Entrance - The customer's installation from the service drop or service lateral connection to and including the service equipment.

DEFINITIONS (CONT'D)

Service Entrance Conductors - The customer's conductors from point of connection at the service drop or service lateral to the service equipment.

Service Equipment - The customer's equipment that controls the electric service and contains the switching and over-current protective devices, usually located near the entry point of the service entrance conductors into the building.

Service Lateral - The underground service conductors or piping connecting BGE's distribution system to the customer's service entrance.

Site Ready - The customer's site must be prepared to enable construction crews and equipment to be deployed to the site and construction activities to commence. The site ready criteria addresses grade, installation of facilities (water, well, septic, sewer, storm drain), location of private underground facilities and property lines, removal of obstructions in the cable path, and installation of transformer pads and duct, if required.

Splice Box - A subsurface enclosure that is used for the purpose of installing, operating or maintaining underground conductors, splices and terminations.

Spotlight - Fixture designed to light a specific area, well defined.

Standard Service - The minimum level of service, as determined by BGE, for the load to which gas and/or electric service is being requested by the customer. Typically, this service is underground at standard voltages and pressures to the BGE designated point of connection. All electric service is alternating current (AC) at 60 hertz (cycles per second).

Start of Construction Date - The first day the crews are on the customer's site to actually perform construction activities.

Stray Light - Emitted light that falls away from areas where it is needed or wanted. Light Trespass.

Tariff - Schedule of BGE rates, charges, and General Rules and Regulations for providing gas & electric service. BGE's Gas and Electric Tariffs are available at bge.com, and is on file with Maryland's Public Service Commission (PSC).

Temporary/Construction Service - A service intended to be used for a limited period, such as for construction, exhibit, or carnival purposes. The temporary facility will be removed at the completion of its use. This may also be referred to as Doubtful Permanency Service.

Transformer - Equipment that converts primary voltage to a lower secondary voltage.

Transformer Vault - An isolated enclosure, above or below ground, with fire resistant walls, ceilings and floor, in which transformers and related equipment are installed and not continuously attended during operation.

Underground Distribution - A distribution system where the conductors and pipes are buried with or without enclosing ducts. Transformers, switches and other equipment are normally above ground, or enclosed in vaults or other enclosures.

URD (Underground Residential Distribution) - An underground distribution system, primarily supplying single phase, three wire service laterals to residential dwelling units. Most conductors are buried. Transformers and primary switches are contained in above ground pad mounted enclosures.

WMS Job Number - An identification number assigned to each job in the BGE Work Management System.

NOTES

FREQUENTLY ASKED QUESTIONS

1. How does a customer initiate an outdoor lighting job with BGE?

- For a street lighting job, submit a completed Service Application and/or a formal written Municipal Request Letter. For a private area lighting job, submit a completed Service Application and/or a lighting request to BGE.
- Download the BGE Service Application for Street Lighting & Private Area Lighting Installation Projects from BGE's web site: bge.com/outdoorlighting.
- Return the completed service application and/or Municipal Request Letter to BGE with the necessary site/building drawings and letter of transmittal for approved street light plan or Request for Proposal, if applicable, to:

BGE – Customer Planning Department
 Service Application Unit
 1068 N. Front Street, Room 501
 Baltimore, MD 21202

This will provide BGE with all the information required to get started.

2. What information is required to request lighting service?

- Full address (street number and name) of project location
- Company legal name
- Contact information
- Phone number(s) where the contact(s) can be reached
- Name of development and lot number (developers only)
- Type of service requested, e.g., new install, change/upgrade, relocation, removal
- Requested completion date for service
- Scaled site plan (minimum scale of 1" = 50')
- Letter of transmittal for approved street light plan or Request for Proposal (street lighting jobs)
- Pole and light numbers for relocation, change, upgrade, or removal of BGE outdoor lighting
- Sketch with notations of project, if a site plan is not available

3. What happens after the customer submits an application for outdoor lighting service?

- A BGE Lighting Account Representative may contact the customer to review job details and

discuss scope of work, job information, proposed light locations and requested service date.

- BGE will develop an engineering plan or preliminary routing sketch proposing the work plan to meet the lighting request.
 - A site visit may be required to check clearances, discuss equipment details, and verify light locations
- BGE will estimate job costs and associated charges. A contract with monthly charges, if applicable, and/or an Extension/Relocation contract for any upfront costs will be sent to the customer.
- Customer should return the contact(s) to BGE at:
 BGE – Outdoor Lighting Contract(s)
 Attention: BGE *Lighting Account Representative's Name*
 1068 N. Front Street, Room 501
 Baltimore, MD 21202

4. How soon will the customer hear from BGE?

- A BGE Lighting Account Representative will respond within approximately 10 days after BGE receives the service application.

5. What happens if a customer needs more than the standard level of service?

- Anytime BGE is required to deviate from our standard practices and procedures, the customer will be responsible for all additional costs. This may include:
 - Design revisions
 - Multiple designs
 - Job scope changes
 - More than one site visit

6. What happens if the site is not ready for construction?

- BGE will not begin construction until the customer has confirmed to BGE's satisfaction that the site is ready for construction.
- If BGE determines the site is not ready for construction when the BGE construction crew arrives at the mutually agreed upon start date, the customer will be required to pay for any costs associated with this failure.

7. What responsibilities must a customer fulfill before receiving lighting service (including site readiness)?

- If applicable, return the signed extension/relocation contract.

FREQUENTLY ASKED QUESTIONS (CONT'D)

- Submit full payment for your extension/relocation project to BGE. Work will not begin until we receive full payment for your project.
 - Grade the site to within 6 inches of final grade.
 - Install customer ducts, manholes and transformer pads.
 - Locate and clearly mark proposed transformer locations.
 - Install transformer pads and conduits with pull strings.
 - Install non-BGE facilities at the site, e.g., water, sewer, telephone, storm drains.
 - Locate and mark all private underground facilities at the site, e.g., well water line, septic field, private lighting, underground sprinkler system.
 - Clear the site of all trees, stumps, debris, and other obstructions.
 - Provide BGE access to your property by returning any necessary utility easement or right-of-way agreements, signed and notarized.
 - Ensure that areas around BGE facilities are free and clear of obstructions per BGE specifications.
- 8. How does a customer upgrade or relocate the existing lighting service?**
- Submit a completed BGE Service Application for Street Lighting & Private Area Lighting Installation Projects that includes:
 - Provide a scaled site plan.
 - Provide pole and light numbers; include all wood pole metal tag(s) and/or yellow light location tag(s) on the site plan (clearly marked with what you want done), or describe the work to be done in the “scope of work” portion of the service applications.
 - If a site plan is not available, use the sketch area of the service application indicating the requested lighting layout.
- 9. Does BGE install underground telephone and cable TV with their utilities?**
- Yes, BGE has agreements with many of these service providers. Just note this interest on your residential or commercial/industrial service application.
- 10. How does a customer report a lighting outage?**
- Report a lighting outage online at bge.com/outdoorlighting or call BGE at 800.685.0123.
- 11. Who owns street lights?**
- For overhead supplied lighting, BGE will provide, own and maintain all equipment as listed and priced under the Street Lighting tariff. For underground supplied lighting, several options for ownership and maintenance are available. Please refer to the current Schedule SL tariff at bge.com/outdoorlighting.
- 12. Who owns Private Area Lights?**
- Under the Private Area Lighting tariff, BGE must install, own and maintain the entire private area lighting system.
- 13. How does a customer obtain photometrics IES files?**
- Obtain photometrics IES files by calling BGE at 410.470.9446 or by contacting a BGE Lighting Account Representative.
- 14. What happens if the customer changes the deliverables of a job (i.e., timeframe, job scope, locations of lights)?**
- Promptly informing BGE of any changes in a lighting job will allow us to keep the customer informed if there are additional charges or potential schedule delays as a result of the requested changes.
- 15. Is the lamppost in a customer’s yard a Private Area Light (PAL)? Who maintains it?**
- If the lamp is electric and fed from the customer’s house, it is not a PAL. In this case, the light is owned and maintained by the customer.
- 16. Does BGE provide outdoor lighting supplied by natural gas?**
- New natural gas supplied outdoor lamp lighting is no longer contracted through BGE’s Outdoor Lighting program. At the customer’s request existing outdoor gas lamp lines are safely decommissioned by BGE. After decommissioning, the abandoned outdoor gas lamp, support structure and section of gas line become the property of the landowner.
- 17. How often are new lighting technologies available?**
- New lighting technologies may become available periodically and BGE may test new products. The current lighting product line is available at bge.com/outdoorlighting.
- 18. Does BGE provide senior citizen pricing?**
- A discount for senior citizens is not available. BGE’s rates are approved by the Public Service Commission and included in the Electric Retail Tariff, which can be found at bge.com.

FREQUENTLY ASKED QUESTIONS (CONT'D)

- 19. **Can a customer pay for lighting services by credit card?**
 - Payment for lighting services is generally made by check or money order. Other options for paying lighting charges included on the monthly BGE bill may be available; however, an additional charge may apply.

- 20. **How does a customer know if enough power to feed a facility or lights on the property exists?**
 - Electric needs for a lighting project will be determined during the preliminary design phase. BGE's electric equipment has definite capacity limitations and can be damaged by overloads. Alterations to the distribution system may be necessary as a result of lighting installations. A BGE Lighting Account Representative will contact the customer if modifications are necessary and if any additional charges apply.

- 21. **Why does it take so long to get lights installed?**
 - BGE has to do a large amount of design and administrative work in preparation for a lighting installation. This ensures the work meets BGE's specifications for reliability and safety, and records for billing and maintenance are accurate.

- 22. **How does a customer obtain product specifications for design criteria?**
 - Please call BGE at **410.470.9446** (toll free **800.685.0123**), or visit us online at **bge.com/outdoorlighting** for additional information and most up to date product offerings.

NOTES

NOTES

Is Your Site Ready?

- 1. Customer ducts and transformer pad must be installed as shown on your signed BGE Design plan and in accordance with BGE specifications. Some materials are available and may be purchased and delivered to your site from BGE's Contractor Supplier by contacting 302.292.2660.**
- 2. Please make sure you have complied with the following agreed-upon site preparation for our equipment:**
 - Site must be within six inches of final grade.
 - Install and mark in 3' intervals: water, sewer, storm drain and all other non-BGE utilities.
 - Locate and clearly mark all private underground facilities on private property. Examples include: well water line, septic field, private lighting, underground sprinkler system, invisible fence wires, etc.
 - Clear the site of all building materials, trees, stumps, and other obstructions along the route of the proposed BGE facilities.
 - Locate and clearly mark proposed property/curb lines on your job site.
 - Locate and clearly mark proposed transformer locations.
 - Install transformer pads and conduits with pull strings.
 - Install Load Cable/Gas Piping through building wall.



P.O. Box 1475

Baltimore, Maryland 21203